

Dell EMC PowerEdge R240

Technical Guide

Notes, cautions, and warnings

 **NOTE:** A NOTE indicates important information that helps you make better use of your product.

 **CAUTION:** A CAUTION indicates either potential damage to hardware or loss of data and tells you how to avoid the problem.

 **WARNING:** A WARNING indicates a potential for property damage, personal injury, or death.

Chapter 1: Product overview	5
Introduction.....	5
New technologies.....	5
Chapter 2: System features	7
Product comparison.....	7
Product specifications.....	8
Chapter 3: Chassis views and features	11
Front view of the system.....	11
Rear view of the system.....	12
Inside the system.....	13
Locating the information tag of your system.....	14
Chapter 4: Processor	16
Processor features.....	16
Supported processors.....	16
Chipset.....	17
Chapter 5: Memory	19
Chapter 6: Storage	21
Supported drives.....	21
Storage controller specifications.....	21
Optical Drives.....	21
Tape Drives.....	21
Internal Dual SD Module.....	22
Chapter 7: Networking and PCIe	23
Chapter 8: Power, thermal, and acoustics	24
Power supply units.....	24
Thermal.....	24
Acoustics.....	25
Chapter 9: Supported operating systems	27
Chapter 10: Dell EMC OpenManage systems management	28
Server and Chassis Managers.....	29
Dell EMC consoles.....	29
Automation Enablers.....	29
Integration with third-party consoles.....	29
Connections for third-party consoles.....	29

Dell EMC Update Utilities.....	29
Dell resources.....	29
Chapter 11: Appendix A. Additional specifications.....	31
Technical specifications.....	31
Chassis dimensions.....	31
Chassis weight.....	32
Video specifications.....	32
USB ports specifications.....	32
Drives.....	32
NIC ports specifications.....	33
Environmental specifications.....	33
Chapter 12: Appendix B. Standards compliance.....	36
Chapter 13: Appendix C Additional resources.....	37
Chapter 14: Appendix D. Support and deployment services.....	38
Dell EMC ProDeploy Enterprise Suite	38
Dell EMC ProDeploy Plus.....	39
Dell EMC ProDeploy.....	39
Dell EMC Basic Deployment.....	39
Dell EMC Residency Services.....	39
Deployment services.....	39
Dell EMC Remote Consulting Services.....	39
Dell EMC Data Migration Service.....	39
ProSupport Enterprise Suite.....	39
ProSupport Plus.....	40
ProSupport.....	40
ProSupport One for Data Center.....	41
Support Technologies.....	41
Additional professional services.....	42
Dell Education Services.....	42
Dell EMC Global Infrastructure Consulting Services.....	42
Dell EMC Managed Services.....	42

Product overview

The Dell EMC PowerEdge R240 is an affordable entry-level, single-socket 1U rack server for SMB and service providers.

The PowerEdge R240 includes four DIMM slots, supports up to 64GB UDIMMs and four 3.5-inch hard drives. The PowerEdge R240 is ideal for web hosting, mail serving, file and print, as well as a wide range of general-purpose productivity applications.



Figure 1. Dell EMC PowerEdge R240

Topics:

- [Introduction](#)
- [New technologies](#)

Introduction

The PowerEdge R240 is versatile enough to address many customer segments and workloads. In particular, the PowerEdge R240 will be best suited for applications and workloads where high availability features are not important within the server node or where redundancy is built at the rack level. Workload targets include:

- Web serving and hosting
- Mail server
- File and Print
- SAN proxy server
- DHCP server
- Surveillance & Security
- Wide variety of mainstream business applications

New technologies

The following table shows the list of new technologies offered by the PowerEdge R240:

New Technologies	Detailed Descriptions
Intel® C246 series chipset	Intel Platform Controller Hub (PCH)
Intel® Xeon® processor E- 2100 and E-2200 Product Family	The Intel® Xeon® E-2100 and E-2200 processors have increased core count and embedded PCIe lanes that will improve the IO performance and a lot more features. Please refer to section 4, Processors for details.
Next Generation SW RAID, PERC S140	The new 1-socket servers support the latest S140 software RAID along with H330 and H730P controller cards with improved functionality and faster performance. New SW RAID supports RAID 0, 1, 5 and 10. Please refer to section 6, for additional details.
iDRAC 9	The new embedded system management solution for Dell EMC server features hardware and firmware inventory and alerting, in depth memory alerting, faster performance, dedicated gigabit port, email alerts, electronic licensing,

New Technologies	Detailed Descriptions
	editable user work notes log and more. Dedicated iDRAC Direct microUSB port improves at-the-box management. Please refer to section 13, for additional details.

System features

Topics:

- [Product comparison](#)
- [Product specifications](#)

Product comparison

The following table shows the comparison between the PowerEdge R230 and PowerEdge R240:

Table 1. Product comparison with predecessor

Feature	PowerEdge R230	PowerEdge R240
Processor	<ul style="list-style-type: none"> • Intel Xeon® E3-1200 v6 Processor family • Intel Pentium® • Intel Celeron® • Intel Core i3® 	<ul style="list-style-type: none"> • Intel Xeon® E-2100 and E-2200 Processor family • Intel Pentium® • Intel Celeron® • Intel Core i3®
Number of processors	<ul style="list-style-type: none"> • 1 	<ul style="list-style-type: none"> • 1
Number of cores	<ul style="list-style-type: none"> • Up to 4 cores 	<ul style="list-style-type: none"> • Up to 8 cores
L2/L3 cache	<ul style="list-style-type: none"> • 2.0 MB per core • 4 MB or 8 MB 	<ul style="list-style-type: none"> • 2.0 MB per core • 8 MB or 12 MB
Chipset	<ul style="list-style-type: none"> • Intel C236 	<ul style="list-style-type: none"> • Intel C246
Memory Module	<ul style="list-style-type: none"> • DDR4: 4 x UDIMMs with ECC • Speed: Up to 2400MT/s • Min RAM: 4 GB • Max RAM: 64 GB 	<ul style="list-style-type: none"> • DDR4: 4 x UDIMMs with ECC • Speed: Up to 2666MT/s • Min RAM: 8GB • Max RAM: 64 GB
Hard drive bays	<ul style="list-style-type: none"> • 2 x 3.5-inch cabled • 4 x 3.5-inch cabled • 4 x 3.5-inch or 2.5-inch hot plug 	<ul style="list-style-type: none"> • 2 x 3.5-inch cabled • 4 x 3.5-inch cabled • 4 x 3.5-inch or 2.5-inch hot plug
Hard drive types	<ul style="list-style-type: none"> • Default SATA. Optional SAS • Enterprise HDD • Entry HDD 	<ul style="list-style-type: none"> • Default SATA. Optional SAS • Enterprise HDD • Entry HDD
External hard drive bays	<ul style="list-style-type: none"> • 1x slim ODD 9.5mm 	<ul style="list-style-type: none"> • 1x slim ODD 9.5mm
RAID controllers	<ul style="list-style-type: none"> • Chipset based SATA, PERC S130 • PERC H330 • PERC H730 • PERC H830 	<ul style="list-style-type: none"> • Chipset based SATA, PERC S140 • PERC H330 • PERC H730P
Host Bus Adapter (HBA)	<ul style="list-style-type: none"> • 12Gb SAS External HBA 	<ul style="list-style-type: none"> • 12Gb SAS External HBA • HBA330 Internal adapter
Boot optimized storage subsystem	<ul style="list-style-type: none"> • Not supported 	<ul style="list-style-type: none"> • 2x M.2 240GB (RAID 1 or No RAID) • 1x M.2 240GB (No RAID only)
Server management	<ul style="list-style-type: none"> • BMC 	<ul style="list-style-type: none"> • BMC

Table 1. Product comparison with predecessor (continued)

Feature	PowerEdge R230	PowerEdge R240
	<ul style="list-style-type: none"> • IPMI 2.0 compliant; Full Open Manage suite • Optional iDRAC8 Express • Optional iDRAC8 Enterprise • Vflash 	<ul style="list-style-type: none"> • IPMI 2.0 compliant; Full Open Manage suite • Optional iDRAC9 Express • Optional iDRAC9 Enterprise • Vflash
I/O slots	<ul style="list-style-type: none"> • 1 x16 slot PCIe Gen3 for HL/FH from CPU1(x8 lanes) • 1 x 8 slot PCIe Gen3 for LP from CPU1(x4 lanes) 	<ul style="list-style-type: none"> • 1 x16 slot PCIe Gen3 for HL/FH from CPU1(x8 lanes) • 1 x 8 slot PCIe Gen3 for LP from CPU1(x4 lanes)
NIC/LOM	<ul style="list-style-type: none"> • 2x GbE LOM 	<ul style="list-style-type: none"> • 2x GbE LOM
USB	<ul style="list-style-type: none"> • 2 rear USB 3.0 • 2 front USB 2.0 • 1 internal USB 3.0 	<ul style="list-style-type: none"> • 2 rear USB 3.0 • 1 front USB 2.0 • 1 internal USB 3.0
Power supplies	<ul style="list-style-type: none"> • 250W AC 1U cable (Bronze) 	<ul style="list-style-type: none"> • 250W AC 1U cable (Bronze) • 450W AC 1U cable (Platinum)
Fans	<ul style="list-style-type: none"> • 3 or 4 non-redundant, non-hot swappable fans 	<ul style="list-style-type: none"> • 3 or 4 non-redundant, non-hot swappable fans
Form factor	<ul style="list-style-type: none"> • 1U rack 	<ul style="list-style-type: none"> • 1U rack
Dimensions (HxWxD)	<ul style="list-style-type: none"> • 42.8 x 434.0 x 551 (mm) (w/o bezel) • 1.67" x 17.09" x 26.2"(in) 	<ul style="list-style-type: none"> • 42.8 x 434.0 x 596 (mm) (w/o bezel) • 1.67" x 17.09" x 23.5"(in)
Weight	<ul style="list-style-type: none"> • Max 20.96 lb/10.6 Kg 	<ul style="list-style-type: none"> • Max 26.89 lb/12.2 Kg

Product specifications

The following table lists the technical specifications for the PowerEdge R240:

Table 2. Technical specifications

Features	Specifications
Form factor	<ul style="list-style-type: none"> • 1U rack
Processors	<ul style="list-style-type: none"> • Intel® Xeon® processor E-2100 and E-2200 product family • Intel® Core™ i3 • Intel® Pentium® • Intel® Celeron
Processor sockets	<ul style="list-style-type: none"> • 1
Front Side Bus or HyperTransport	<ul style="list-style-type: none"> • Intel DMI 3.0
Cache	<ul style="list-style-type: none"> • 2.0 MB per core • 8 MB or 12 MB
Chipset	<ul style="list-style-type: none"> • Intel C246 Chipset
Memory1	<ul style="list-style-type: none"> • Up to 64GB (4 DIMM Slots) • 8GB/16GB 2666MT/s Unbuffered with ECC only • MIN/ MAX RAM: 8GB/64GB
I/O slots	<ul style="list-style-type: none"> • 2 GEN3 PCIe slots: <ul style="list-style-type: none"> ◦ X16 slot FH (1x8 Gen3) ◦ X8 Slot LP (1x4 Gen3)
RAID controller	<ul style="list-style-type: none"> • S140

Table 2. Technical specifications (continued)

Features	Specifications
	<ul style="list-style-type: none"> ● PERC H330 ● PERC H730P
Host Bus Adapter (HBA)	<ul style="list-style-type: none"> ● 12Gb SAS External HBA ● HBA330 Internal adapter
Drive bays	<ul style="list-style-type: none"> ● Up to 4 x 3.5-inch cable drives ● Up to 4 x 3.5-inch or 2.5-inch Hot-Plug drives
Maximum internal storage	<ul style="list-style-type: none"> ● 56.0TB for 4 x HDD config
Hard drives	<ul style="list-style-type: none"> ● 2.5-inch SSD SATA 6Gb ● 2.5-inch SATA 7.2K ● 2.5-inch SAS 15K HDs ● 2.5-inch Near Line SAS 7.2K ● 2.5-inch SAS 10K HDDs ● 3.5-inch Enterprise SATA 7.2K HDDs ● 3.5-inch Near Line SAS 7.2K HDDs ● 3.5-inch 7.2K SATA client drives ● 2.5-inch SAS SSDs <p>HDDs capacities: 300GB, 600GB, 900GB, 1TB, 1.2TB, 1.8TB, 2TB, 2.4TB, 4TB, 6TB, 8TB, 10TB, 12TB, 14TB</p> <p>SSD capacities: 240GB, 480GB, 960GB, 1.2TB, 1.6TB, 1.92TB, 3.84TB, and 7.68TB</p>
Embedded LOM/NIC	<ul style="list-style-type: none"> ● Integrated BROADCOM BCM5720 Gigabit Ethernet Controller
Communications	<p>Optional add-in cards:</p> <ul style="list-style-type: none"> ● 1GbE Intel (Dual) Powerville Troi-Stony Dual port 1Gb Base-T adapter – FH or LP ● 1GbE Intel (Quad) Powerville Lore-Stony Quad port 1Gb Base-T adapter – FH or LP ● 1GbE Broadcom (Dual) 5720 Bashir Dual port 1Gb Base-T adapter – FH or LP ● 1GbE Broadcom (Quad) 5719 Cardassia Quad port 1Gb Base-T adapter – FH or LP
Power supply	<ul style="list-style-type: none"> ● Cabled 250W Bronze power supply (100–240 V AC) ● Cabled 450W Platinum power supply (100–240 V AC)
Availability	<ul style="list-style-type: none"> ● TPM/No TPM ● ECC memory, UDIMM ● Hot-plug hard drives ● Single output power supplies
Video	<ul style="list-style-type: none"> ● Integrated Matrox G200 with iDRAC9
Remote management	<ul style="list-style-type: none"> ● Lifecycle Controller 3.0 ● iDRAC9 Enterprise ● VFlash (Optional)
Systems management	<ul style="list-style-type: none"> ● Dell Open Manage featuring Dell Management Console ● Lifecycle Controller 3.0 ● iDRAC9 Enterprise ● VFlash (Optional)

Table 2. Technical specifications (continued)

Features	Specifications
Rack support	<ul style="list-style-type: none">• ReadyRails™ static rails for tool-less mounting in 4-post racks with square or unthreaded round holes or tooled mounting in 4-post threaded and 2-post (Telco) racks
Featured database applications	<ul style="list-style-type: none">• Microsoft® SQL Server® solutions

Chassis views and features

Topics:

- Front view of the system
- Rear view of the system
- Inside the system
- Locating the information tag of your system

Front view of the system



Figure 2. Front view of the 4 x 3.5-inch drive system

- | | |
|------------------------|--------------------|
| 1. Left control panel | 2. Optical drive |
| 3. Right control panel | 4. Information tag |
| 5. Drive | |



Figure 3. Front view of the 4 x 3.5-inch cabled drive system

- | | |
|------------------------|--------------------|
| 1. Left control panel | 2. Optical drive |
| 3. Right control panel | 4. Information tag |
| 5. Drive | |

NOTE: LED functionality is not supported on cabled hard disk drive configuration.

Rear view of the system

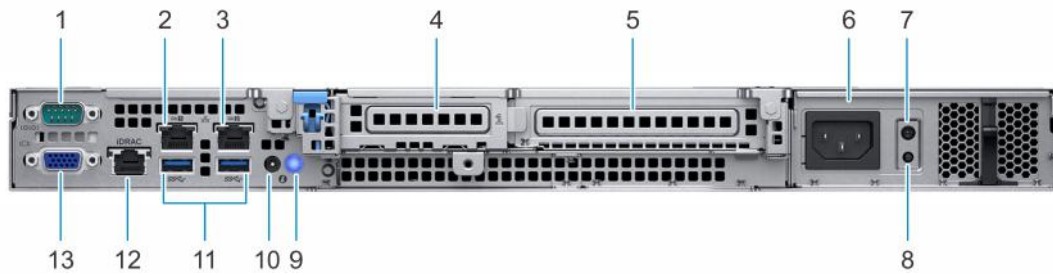

Figure 4. Rear view of the system

- 1. Serial port
- 2. NIC port (Gb 1)
- 3. NIC port (Gb 2)
- 4. Half-height PCIe expansion card slot
- 5. Full-height PCIe expansion card slot
- 6. Power supply unit
- 7. PSU Built-in Self Test (BIST) LED
- 8. PSU Built-in Self Test (BIST) button
- 9. System identification button
- 10. System status indicator cable port (CMA)
- 11. USB 3.0 ports (2)
- 12. iDRAC dedicated NIC port
- 13. VGA port

For more information, see the Dell EMC PowerEdge R240 Technical Specifications on the product documentation page.

Inside the system

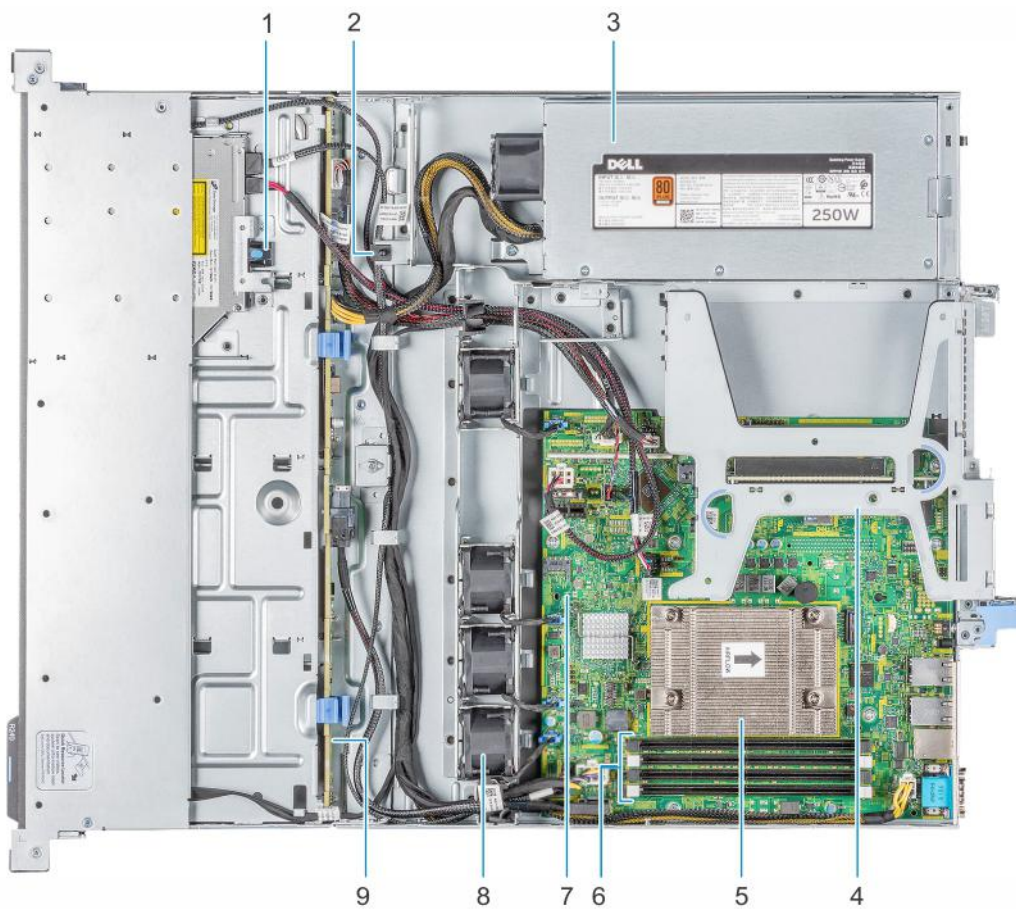

Figure 5. Inside the system - 4 x 3.5-inch drive system

- | | |
|--------------------------------|--------------------------|
| 1. Optical drive | 2. Intrusion switch |
| 3. Cabled AC power supply unit | 4. Expansion card riser |
| 5. Processor and heat sink | 6. Memory module sockets |
| 7. System board | 8. Fan (4) |
| 9. Drive backplane | |

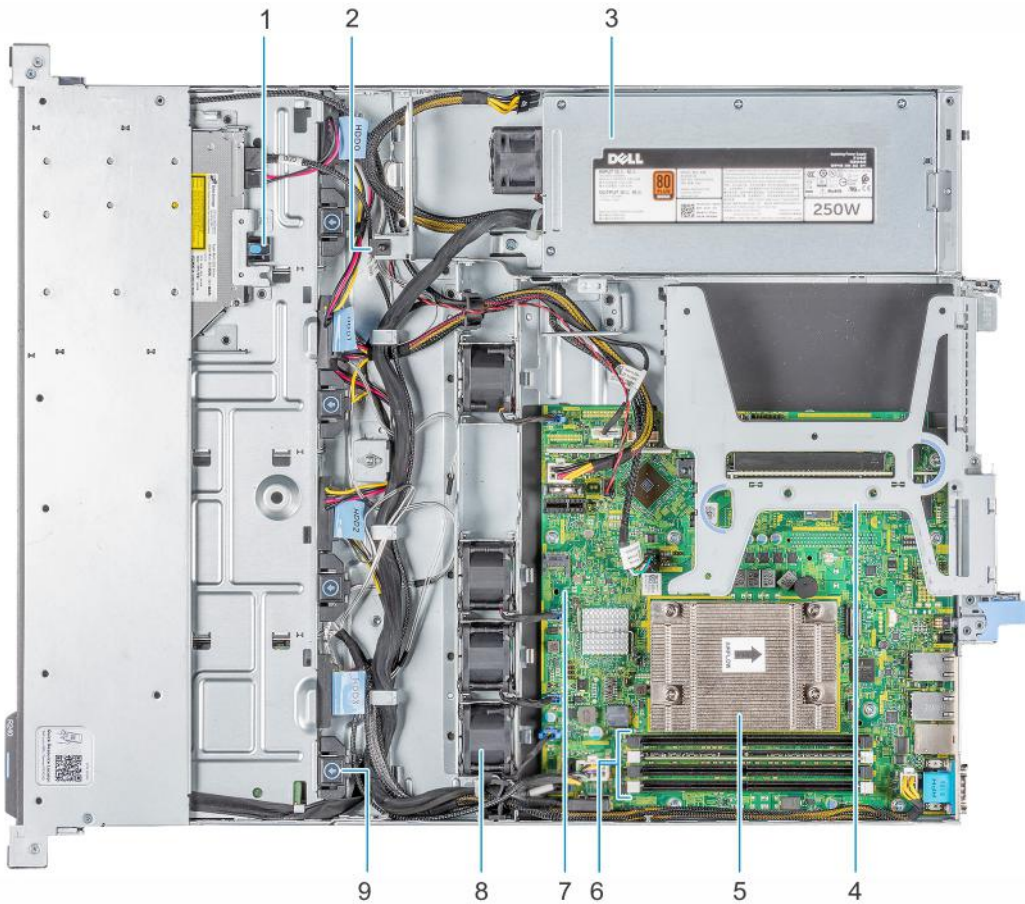

Figure 6. Inside the system - 4 x 3.5-inch cabled drive system

- | | |
|--------------------------------|--------------------------|
| 1. Optical drive | 2. Intrusion switch |
| 3. Cabled AC power supply unit | 4. Expansion card riser |
| 5. Processor and heat sink | 6. Memory module sockets |
| 7. System board | 8. Fan (4) |
| 9. Cabled drive | |

Locating the information tag of your system

Your system is identified by a unique Express Service Code and Service Tag number. You can view the Express Service Code and Service Tag by pulling out the information tag located on the front of the system. Alternatively, the information may be on the Mini Enterprise Service Tag (MEST) label on the chassis, on the rear of the system. This information is used by Dell to route support calls to the appropriate personnel.

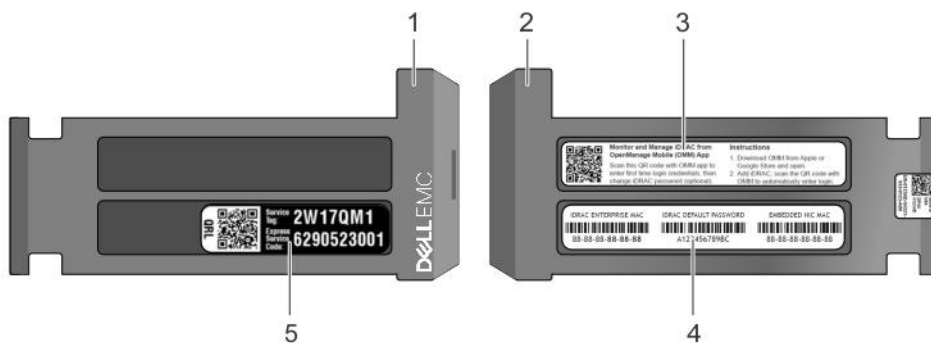

Figure 7. Locating Service Tag of your system

- | | |
|---------------------------------|--------------------------------|
| 1. Information tag (front view) | 2. Information tag (back view) |
|---------------------------------|--------------------------------|

3. OpenManage Mobile (OMM) label

5. Service Tag, Express Service Code, QRL label

4. iDRAC MAC address and iDRAC secure password label

Processor

The PowerEdge R240 is entry-level single-socket rack server based on the Intel® Xeon® E-2100 and E-2200 processor family.

Topics:

- [Processor features](#)
- [Supported processors](#)
- [Chipset](#)

Processor features

The following list highlights the features of the Intel® Xeon E-2100 and E-2200 processor family:

- Up to eight execution cores per processor
- Four DMI3 lanes
- 16 PCIe Gen 3 links capable of 8.0 GT/s
- Socket H4, LGA package (LGA1151)
- Integrated 2 channel DDR4 memory controller
- Execute Disable Bit
- Support Turbo Boost Technology 2.0
- Increases CPU frequency if operating below thermal, power, and current limits
- Intel® Virtualization Technology (Intel® VT)

i **NOTE:** We do not support graphics with E-2100 and E-2200 processors, Graphics cannot be enabled on Dell servers using this processor due to technical restrictions.

Software Guard Extensions (SGX): Intel SGX functions are available on Coffee Lake Refresh SKUs: Xeon E-2274G, E-2276G, E-2286G, E-2288G processors and on these original Coffee Lake SKUs: Xeon E-2174G, E-2176G, E-2186G processors on PowerEdge R240. SGX option will be available in BIOS SETUP only if one of the supported processors are installed.

Supported processors

Table 3. Supported processors

Coffee Lake Refresh Processors									
Model	Speed (GHz)	Power (Watts)	Cores	L3 Cache (MB)	Threads	Turbo	Max Memory Speed (MT/s)	Hyper-threading	SGX Support
E-2288G	3.7	95	8	16	16	Yes	2666	Yes	Y
E-2286G	4.0	95	6	12	12	Yes	2666	Yes	Y
E-2278G	3.4	80	8	12	16	Yes	2666	Yes	N
E-2276G	3.8	80	6	12	12	Yes	2666	Yes	Y
E-2274G	4.0	83	4	8	8	Yes	2666	Yes	Y
E-2246G	3.6	80	6	12	12	Yes	2666	Yes	N
E-2244G	3.8	71	4	8	8	Yes	2666	Yes	N
E-2236	3.4	80	6	12	12	Yes	2666	Yes	N
E-2234	3.6	71	4	8	8	Yes	666	Yes	N

Table 3. Supported processors (continued)

Coffee Lake Refresh Processors									
Model	Speed (GHz)	Power (Watts)	Cores	L3 Cache (MB)	Threads	Turbo	Max Memory Speed (MT/s)	Hyper-threading	SGX Support
E-2226G	3.4	80	6	12	6	Yes	2666	Yes	N
E-2224	3.4	71	4	8	4	Yes	2666	Yes	N
Core i3 9100	3.6	65	4	8	4	No	2666	No	N
Pentium G5420	3.8	58	2	4	4	No	2666	No	N
Celeron G4930	3.2	54	2	2	2	No	2666	No	N

Coffee Lake Refresh Processors									
Model	Speed (GHz)	Power (Watts)	Cores	L3 Cache (MB)	Threads	Turbo	Max Memory Speed (MT/s)	Hyper-threading	SGX Support
E-2186G	3.8	95	6	12	12	Yes	2666	Yes	Y
E-2176G	3.7	80	6	12	12	Yes	2666	Yes	Y
E-2174G	3.8	71	4	8	8	Yes	2666	Yes	Y
E-2146G	3.5	80	6	12	12	Yes	2666	Yes	N
E-2144G	3.6	71	4	8	8	Yes	2666	Yes	N
E-2136	3.3	80	6	12	12	Yes	2666	Yes	N
E-2134	3.5	71	4	8	8	Yes	2666	Yes	N
E-2126G	3.3	80	6	12	6	Yes	2666	No	N
E-2124 *	3.3	71	4	8	4	Yes	2666	No	N
Core i3 8100	3.6	65	4	6	4	No	2666	No	N
Pentium G5500	3.8	54	2	4	2	No	2666	No	N
Celeron G4900	3.1	54	2	2	2	No	2666	No	N

Chipset

The PowerEdge R240 incorporates the Intel® C246 chipset. The following high level features supported by the chipset and may not be implemented on R240:

PCH feature	C246	R240
PCH feature	C246	R240
TXT	Y	Y
Node Manager	Y	N
ECC	Y	Y

PCH feature	C246	R240
FlexIO - USB3.0 - 10 (means 6 is enough)	10	3
USB 2.0	4	4
FlexIO - 8 SATA ports	8	5
FlexIO - SATA Express	3	0
FlexIO - PCIE 3.0 ports - additional required	20	8
SPI (MB) FW image	7	UI
Intel vPRO/AMT11	Y	N
Rapid Storage technology	Y	N
Rapid Storage technology enterprise	Y	N
Data Center Graphics	N	N
supported displays	3	N
Int. Gbe MAC	Y	N
eSPI	Y	N
IO Flex - ability to change SATA/PCIE/USB	Y	N
Software Guard Extensions (SGX)	N	Y

- Direct Media Interface 3 (DMI3) connects the CPU1 to the PCH
- PCI Express Generation 3 (PCIe Gen3) is capable of 8 GT/s bit rate
- PCH SATA controller provides hardware support for Advanced Host Controller Interface (AHCI), a standardized programming interface for SATA host controllers developed through a joint industry effort.
- Low Pin Count Interface (LPC)
- Serial Peripheral Interface (SPI)
- Advanced Programmable Interrupt Controller (APIC)
- Real-Time Clock
- GPIO Serial Expander (GSX) is the capability provided by the PCH to expand the GPIOs on a platform that needs more GPIOs than the ones provided by the PCH.
- System Management Bus (SMBus) 2.0
- JTAG Boundary-Scan

Memory

The PowerEdge R240 Integrated Memory Controller (IMC) supports DDR4/-RS protocols with two independent, 64-bit wide channels.

The maximum system population at launch will be 64GB. (4 DIMM slots x16 GB DDR4 UDIMM)

- System Memory Organization Modes
 - The IMC supports two memory organization modes, single-channel and dual-channel. Depending upon how the DDR Schema and DIMM Modules are populated in each memory channel, a number of different configurations can exist.
- Single-Channel Mode
 - In this mode, all memory cycles are directed to a single channel. Single-Channel mode is used when either the Channel A or Channel B DIMM connectors are populated in any order, but not both.
- Dual-Channel Mode – Intel® Flex Memory Technology Mode
 - The IMC supports Intel Flex Memory Technology Mode. Memory is divided into a symmetric and asymmetric zone. The symmetric zone starts at the lowest address in each channel and is contiguous until the asymmetric zone begins or until the top address of the channel with the smaller capacity is reached. In this mode, the system runs with one zone of dual-channel mode and one zone of single-channel mode, simultaneously, across the whole memory array.

Memory Features

Key features of the PowerEdge R240 memory system include:

- Unbuffer (UDIMM) ECC DDR4 technology
- Each channel carries 64 data and 8 ECC bits
- Up to 64 GB of UDIMM memory (4 x 16GB UDIMM)
- Up to 2666 MT/s DIMMs
- Single DIMM configuration with 8 GB DIMM at socket DIMM A1
- Flexible Memory Configuration
- ODT (On Die Termination)
- Clock gating (CKE) to conserve power when DIMMs are not accessed
 - DIMMs enter a low power self-refresh mode
- I2C access to SPD EEPROM for access to thermal sensors
- Memory Optimized (Independent Channel) Mode
- 100% Single Bit Error Correction
- Memory Off-lining is NOT supported

Memory speed

The system will run all memory on all CPUs and channels at the same speed and voltage. By default the system will run at the highest speed for the lowest voltage of the worst case channel DIMM configuration.

Operating speed of the memory is determined by:

- Supported speed of the DIMMs
- DIMM configuration on any channel
- Max speed supported by the CPU
- Speed requested by user in BIOS setup screen

Operating voltage of the system is determined by:

- Voltages supported by the DIMMs which is 1.2V
- Voltage supported by the platform.

The following table shows the memory populations and the system speed frequencies:

Table 4. Memory populations and system speed

DIMM Type	DIMM Ranking	Capacity	DIMM Rated voltage	1 DIMM per channel	2 DIMMs per channel
UDIMM	1R/2R	8GB, and 16GB	DDR4 (1.2V)	2666	2666

Supported Configurations

The following table highlights the PowerEdge R240 DIMM offering list

DIMM Speed	DIMM Type	DIMM Capacity (GB)	Ranks per DIMM	Data Width	SDDC Support	DIMM Volts	Comments
2666	UDIMM	8	1	x8	Advanced ECC	1.2	
2666	UDIMM	8	1	x8	Advanced ECC	1.2	BCC Version
2666	UDIMM	16	1	x8	Advanced ECC	1.2	
2666	UDIMM	16	1	x8	Advanced ECC	1.2	BCC Version
2400	UDIMM	4	1	x8	Advanced ECC	1.2	
2400	UDIMM	8	1	x8	Advanced ECC	1.2	
2400	UDIMM	8	1	x8	Advanced ECC	1.2	BCC Version
2400	UDIMM	16	2	x8	Advanced ECC	1.2	
2400	UDIMM	16	2	x8	Advanced ECC	1.2	BCC Version
2133	UDIMM	4	1	x8	Advanced ECC	1.2	
2133	UDIMM	4	1	x8	Advanced ECC	1.2	BCC Version
2133	UDIMM	8	2	x8	Advanced ECC	1.2	
2133	UDIMM	8	1	x8	Advanced ECC	1.2	BCC Version
2133	UDIMM	16	2	x8	Advanced ECC	1.2	
2133	UDIMM	16	2	x8	Advanced ECC	1.2	BCC Version

Storage

The PowerEdge R240 supports the following drive configurations:

- 2 x 3.5-inch cabled HDD configuration
- 4 x 3.5-inch cabled HDD configuration
- 4 x 3.5-inch hot-plug HDD configuration
- 4 x 2.5-inch (in 3.5-inch carrier) hot-plug HDD configuration

Topics:

- [Supported drives](#)
- [Storage controller specifications](#)
- [Optical Drives](#)
- [Tape Drives](#)
- [Internal Dual SD Module](#)

Supported drives

The PowerEdge R240 system supports SAS, SATA, Nearline SAS drives and SSD drives.

i **NOTE:** SSD drives only available in the hot-plug configurations

Table 5. Supported Drives

	x2 cabled chassis	x4 cabled chassis	x4 hot plug hard drive
Hard drive form factor	3.5-inch only	3.5-inch only	3.5-inch or 2.5-inch only
Hard drive type	SATA, Nearline SAS	SATA, Nearline SAS	SATA, Nearline SAS, SAS, SSD

i **NOTE:** Both 6Gbps and 12Gbps drives are supported by the PowerEdge R240

Storage controller specifications

The PowerEdge R240 system supports:

- Internal storage controller cards: PERC H330, H730P, S140, HBA330 and Boot Optimized Storage Subsystem (BOSS) modules.
- External storage controller cards: 12 Gbps SAS HBA.

Optical Drives

The PowerEdge R240 supports one of the following internal optical drive options:

- DVD-ROM
- DVD+ROM

Tape Drives

Due to its dense form factor, the PowerEdge R240 does not support internal tape drives. However, here is a list of supported external tape backup devices:

Supported external tape drives:

- External LTO-6 SAS tape drives
- External LTO-7 SAS tape drives
- External LTO-8 SAS tape drives

Internal Dual SD Module

The Internal Dual SD Module (iDSDM) is optional. The iDSDM contains two SD ports directly on the motherboard. The modules are redundant. Supported iDSDM microSD cards capacity are 8/16/32/64GB

The iDSDM card provides the following functions:

- Dual SD interface is maintained in a mirrored configuration (primary and secondary SD)
- Provides full RAID1 functionality
- Dual SD cards are not required; the module can operate with only one card but will provide no redundancy
- Enables support for Secure Digital eXtended Capacity (SDXC) cards
- USB interface to host system
- I²C interface to host system and onboard EEPROM for out-of-band status reporting
- Onboard LEDs show status of each SD card
- A BIOS Setup Redundancy setting supports Mirror Mode or Disabled

Boot Optimized Storage Subsystem (BOSS)

BOSS is offered as a means of booting the PowerEdge R240 servers to a full OS when:

- A solution such as iDSDM may be desired, but the target OS for BOSS is a full OS (not just a hypervisor)
- The user needs to maximize their number of drive bays

BOSS cards take up a PCIe slot and are not hot-plug capable. 1x or 2x 240GB modules are available. Dual (2x) module configs can be set up for either RAID 1 or No RAID. Single (1x) module configs can only be set up in a No RAID config.

Networking and PCIe

The following lists the supported add in communication cards:

- Intel Ethernet I350 DP 1Gb server adapter – FH or LP
- Intel Ethernet I350 QP 1Gb server adapter – FH or LP
- Broadcom 5720 DP 1Gb Network Interface Card – FH or LP
- Broadcom 5719 QP 1Gb Network Interface Card – FH or LP

PCIe slots

The PowerEdge R240 provides one riser PCIe expansion slot and one R/A PCIe internal storage slot:

- Slot 1 : One x8 PCIe Gen3 for LP from CPU (x4 lanes)
- Slot 2 : One x16 PCIe Gen3 for FH/HL from CPU (x8 lanes)

PCI card dimensions

The PCI card dimensions allowed in the PowerEdge R240 are as below:

Table 6. PCI card dimensions

Card type	Height	Length
Slot 1 (Low Profile, half length card)	68.90 mm (2.731 inches) max	167.65 mm (6.600 inches) max
Slot 2 (Full height, Half length card)	111.15 mm (4.376 inches) max	167.65 mm (6.600 inches) max

Power, thermal, and acoustics

Topics:

- Power supply units
- Thermal
- Acoustics

Power supply units

The power supply subsystem is formed with a AC-DC cable power supply. The power supply provides +12V and +12Vaux for non-redundant design. There are several voltage regulators in the system to supply different voltage levels needed by different logic devices.

The Dell EMC PowerEdge R240 supports 250W and 450W cabled AC power supply units (PSU).

The following table shows the technical specifications of the power supply:

Table 7. Dell EMC PowerEdge R240 PSU specifications

PSU	Class	Heat dissipation (maximum)	Frequency	Voltage	AC		Current
					High line 100–240 V	Low line 100–120 V	
250 W AC	Bronze	1039 BTU/hr	50/60 Hz	100-240 V AC, autoranging	250 W	N/A	4.0A - 2.0 A
450 W AC	Platinum	1725 BTU/hr	50/60 Hz	100-240 V AC, autoranging	450 W	NA	6.5A - 3.5A

NOTE: This system is designed to connect to the IT power systems with a phase-to-phase voltage not exceeding 230 V.

Thermal

The thermal design of the PowerEdge R240 reflects the following:

- Optimized thermal design
 - The system layout is architected for an optimum thermal design i.e. system component placement and layout are designed to provide maximum airflow coverage to critical components with minimum expense of fan power.
 - Custom heat sink designs for CPU, chipset for optimum component cooling
- Comprehensive thermal design
 - The power required to cool a server can contribute a significant amount to the overall system power. Thermal control is the active management of system cooling through fan speed and system power management to make sure that the system is reliable while minimizing system fan power consumption, airflow, and system acoustic output.
 - The PowerEdge R240 thermal control system regulates the fan speed based on several different responses from critical components' temperature sensors as well as inventory for system configurations:
 - Open and closed loop fan speed control. Open loop control uses system configuration information to determine fan speed based on system inlet temperature. Closed loop control method uses component temperature feedback from various sub-systems to dynamically determine optimum fan speeds.
 - Increase airflow through a fan offset if required.
 - Increase airflow through increasing minimum fan speed.

Acoustics

PowerEdge R240 acoustics

Dell EMC PowerEdge R240 is a rack-mount server appropriate for attended data center environment. However, lower acoustical output is attainable with proper hardware or software configurations. For example, the minimum configuration of PowerEdge R240 is quiet enough for typical office environment. The list below are the PowerEdge R240's acoustical dependencies:

- **Ambient Temperature:** For a similar workload fan speeds (and thus, acoustical noise) may increase as ambient temperature increases.
- **High Wattage CPU:** High-power (TDP) CPU parts may result in higher acoustical noise output.
- **Rear Drives:** When rear drives are installed in R340, fan speed may increase for cooling the drives, and hence both idle and operating acoustical outputs may be higher.
- **System Thermal Profile Selected in BIOS:** The default setting is "Power Optimized (DAPC)", which generally means lower fan speed and acoustics. If "Performance Optimized" is selected, fan speed and acoustical noise may increase.

The PowerEdge R240 acoustical performance is characterized for 3 configurations: Minimum, Typical and Feature Rich. The following tables summarizes the configuration and acoustical performance of the PowerEdge R240. Each configuration has been tested according to Dell EMC acoustical standards for rack-mounted servers.

Configuration	Minimum	Typical-1	Typical-2	Feature Rich
CPU Type	Intel E-2124	Intel E-2124	Intel E-2124	Intel E-2126G
CPU TDP	71 W	71 W	71 W	80 W
CPU Quantity	1	1	1	1
Memory Type	8GB UDIMM	8GB UDIMM	16GB UDIMM	16GB UDIMM
DIMM Quantity	1	1	2	4
Backplane Type	2x 3.5" Cabled	4x 3.5" Cabled	4X 3.5" Hot-plug	4X 3.5" Hot-plug
Fan Quantity	2 x 4028	3 x 4028	4 x 4028	4 x 4028
HDD Type	3.5" SATA 1-TB	3.5" SATA 1-TB	3.5" SATA 2-TB	3.5" SATA 2-TB
HDD Quantity	1	2	2	4
PSU Type	250 W	250 W	250 W	250 W
PSU Quantity	1	1	1	1
PCI 1	-	- PERC H330		PERC H330
PCI 2	-	-	-	-
PCI 3	-	-	-	-

Acoustical Performance: Idle/ Operating @ 25 °C Ambient					
LwA-UL ² (Bels)	Idle 1	4.6	4.6	5.1	5.2
	Operating 1	4.7	4.8	5.1	5.2
LpA ³ (dBA)	Idle 1	39	39	43	43
	Operating 1	40	40	43	43

Acoustical Performance: Idle @ 28 °C Ambient				
LwA-UL ² (Bels)	5.5	5.7	6.1	6.1
LpA ³ (dBA)	38	41	45	44

Acoustical Performance: Max. Loading @ 35 °C Ambient				
LwA-UL ² (Bels)	7.7	7.7	7.8	7.8
LpA ³ (dBA)	59	61	62	62

Supported operating systems

The following lists the supported operating systems for the PowerEdge R240:

- Windows 2019 w/Hyper-V Standard
- Windows 2019 Essentials
- Windows 2016 w/Hyper-V Standard
- Windows 2016 Essentials
- Windows 2012 R2 Essentials
- Windows 2012 R2 Standard

 **NOTE:** Windows 2012 R2 is not supported with E-2200 processor configurations.

- RHEL 7.5
- SLES 15
- Ubuntu server 18.04.1
- Citrix XenServer 7.1
- VMWare ESXi 6.7
- VMWare ESXi 6.5

Dell EMC OpenManage systems management

Dell EMC OpenManage Portfolio

Simplifying hardware management through ease of use and automation

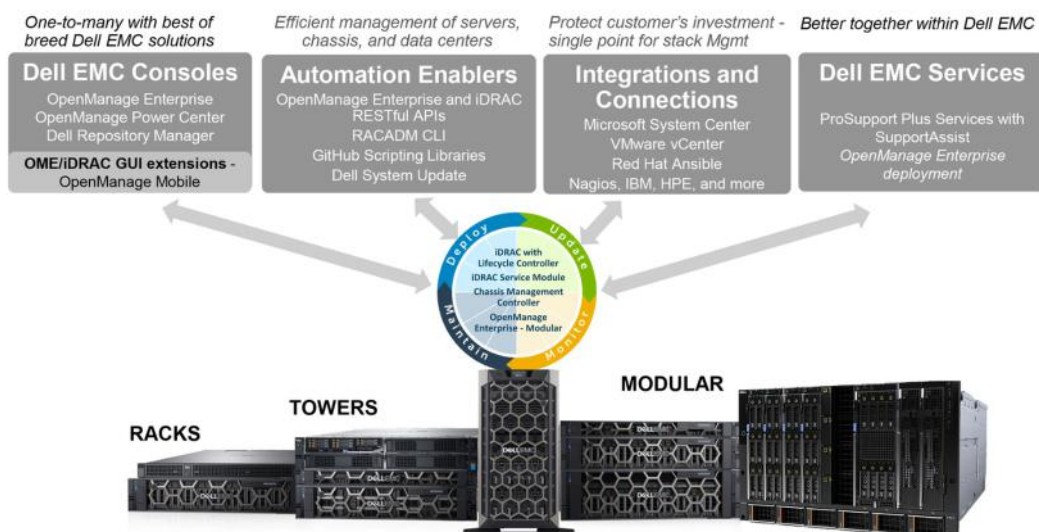

Figure 8. Dell EMC OpenManage Portfolio

Dell EMC delivers management solutions that help IT Administrators effectively deploy, update, monitor, and manage IT assets. OpenManage solutions and tools enable you to quickly respond to problems by helping them to manage Dell EMC servers effectively and efficiently; in physical, virtual, local, and remote environments, operating in-band, and out-of-band (agent-free). The OpenManage portfolio includes innovative embedded management tools such as the integrated Dell Remote Access Controller (iDRAC), Chassis Management Controller and Consoles like OpenManage Enterprise, OpenManage Power Manager plug in, and tools like Repository Manager.

Dell EMC has developed comprehensive systems management solutions based on open standards and has integrated with management consoles that can perform advanced management of Dell hardware. Dell EMC has connected or integrated the advanced management capabilities of Dell hardware into offerings from the industry's top systems management vendors and frameworks such as Ansible, thus making Dell EMC platforms easy to deploy, update, monitor, and manage.

The key tools for managing Dell EMC PowerEdge servers are iDRAC and the one-to-many OpenManage Enterprise console. OpenManage Enterprise helps the system administrators in complete lifecycle management of multiple generations of PowerEdge servers. Other tools such as Repository Manager, which enables simple yet comprehensive change management.

OpenManage tools integrate with systems management framework from other vendors such as VMware, Microsoft, Ansible, and ServiceNow. This enables you to use the skills of the IT staff to efficiently manage Dell EMC PowerEdge servers.

Topics:

- [Server and Chassis Managers](#)
- [Dell EMC consoles](#)
- [Automation Enablers](#)
- [Integration with third-party consoles](#)
- [Connections for third-party consoles](#)
- [Dell EMC Update Utilities](#)
- [Dell resources](#)

Server and Chassis Managers

- Integrated Dell Remote Access Controller (iDRAC)
- iDRAC Service Module (iSM)

Dell EMC consoles

- Dell EMC OpenManage Enterprise
- Dell EMC Repository Manager (DRM)
- Dell EMC OpenManage Enterprise Power Manager plugin to OpenManage Enterprise
- Dell EMC OpenManage Mobile (OMM)

Automation Enablers

- OpenManage Ansible Modules
- iDRAC RESTful APIs (Redfish)
- Standards-based APIs (Python, PowerShell)
- RACADM Command Line Interface (CLI)
- GitHub Scripting Libraries

Integration with third-party consoles

- Dell EMC OpenManage Integrations with Microsoft System Center
- Dell EMC OpenManage Integration for VMware vCenter (OMIVV)
- Dell EMC OpenManage Ansible Modules
- Dell EMC OpenManage Integration with ServiceNow

Connections for third-party consoles

- Micro Focus and other HPE tools
- OpenManage Connection for IBM Tivoli
- OpenManage Plug-in for Nagios Core and XI

Dell EMC Update Utilities

- Dell System Update (DSU)
- Dell EMC Repository Manager (DRM)
- Dell EMC Update Packages (DUP)
- Dell EMC Server Update Utility (SUU)
- Dell EMC Platform Specific Bootable ISO (PSBI)

Dell resources

For additional information about white papers, videos, blogs, forums, technical material, tools, usage examples, and other information, go to the OpenManage page at <https://www.dell.com/openmanagemanuals> or the following product pages:

Table 8. Dell resources

Resource	Location
Integrated Dell Remote Access Controller (iDRAC)	https://www.dell.com/idracmanuals
iDRAC Service Module (iSM)	https://www.dell.com/support/article/sln310557
OpenManage Ansible Modules	https://www.dell.com/support/article/sln310720
OpenManage Essentials (OME)	https://www.dell.com/support/article/sln310714
OpenManage Mobile (OMM)	https://www.dell.com/support/article/sln310980
OpenManage Integration for VMware vCenter (OMIVV)	https://www.dell.com/support/article/sln311238
OpenManage Integration for Microsoft System Center (OMIMSSC)	https://www.dell.com/support/article/sln312177
Dell EMC Repository Manager (DRM)	https://www.dell.com/support/article/sln312652
Dell EMC System Update (DSU)	https://www.dell.com/support/article/sln310654
Dell EMC Platform Specific Bootable ISO (PSBI)	Dell.com/support/article/sln296511
Dell EMC Chassis Management Controller (CMC)	www.dell.com/support/article/sln311283
OpenManage Connections for Partner Consoles	https://www.dell.com/support/article/sln312320
OpenManage Enterprise Power Manager	https://www.dell.com/solutions/openmanage/power-management.htm
OpenManage Integration with ServiceNow (OMISNOW)	Dell.com/support/article/sln317784

 **NOTE:** Features may vary by server. Please refer to the product page on <https://www.dell.com/manuals> for details.

Appendix A. Additional specifications

The following sections contain information about additional system specifications.

Topics:

- [Technical specifications](#)

Technical specifications

The technical and environmental specifications of your system are outlined in this section.

Chassis dimensions

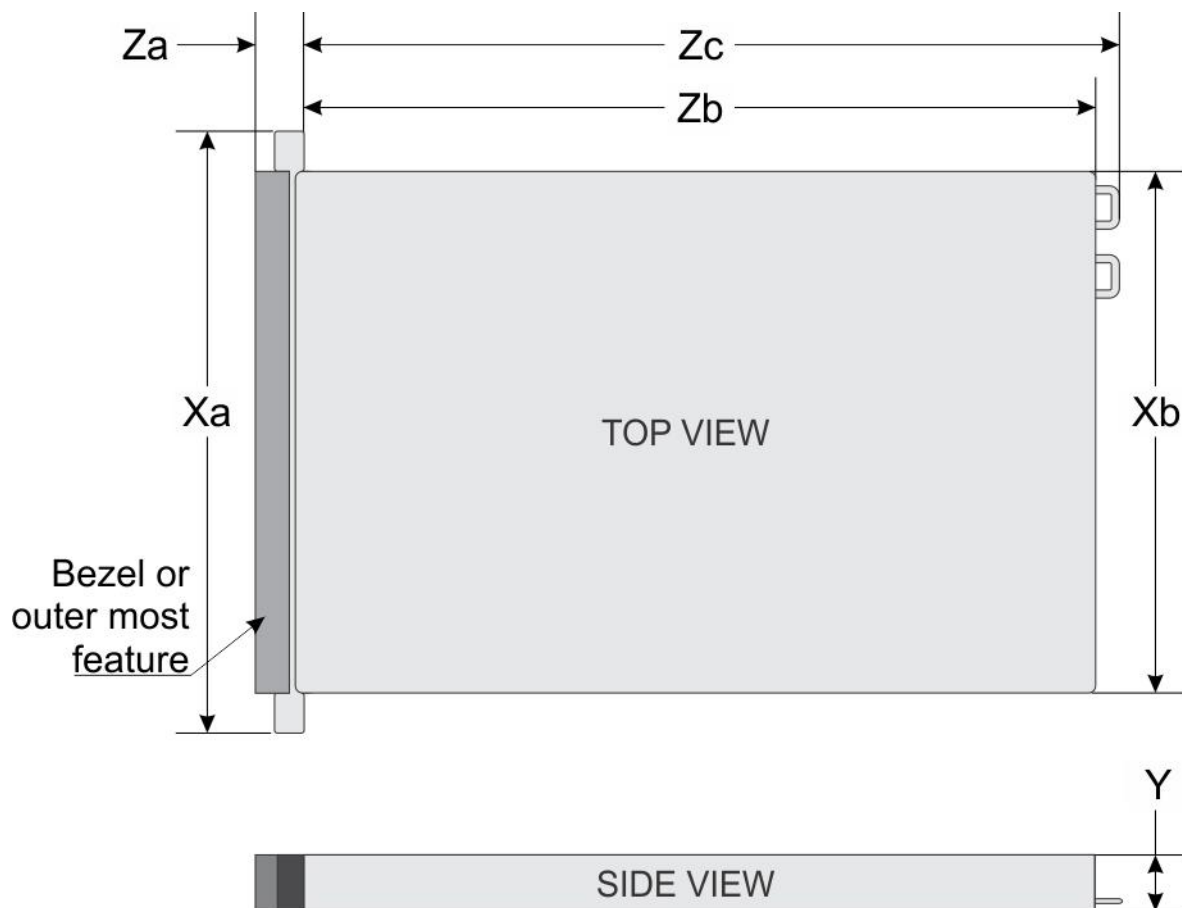

Figure 9. Chassis dimensions

Table 9. Dell EMC PowerEdge R240 chassis dimensions

Xa	Xb	Y	Za	Zb	Zc
482.0 mm (18.97 inches)	434.0 mm (17.08 inches)	42.8 mm (1.68 inches)	With bezel: 35.64 mm (1.4 inches)	534.496 mm (21.04 inches)	573.596 mm (22.58 inches)

Table 9. Dell EMC PowerEdge R240 chassis dimensions

Xa	Xb	Y	Za	Zb	Zc
			Without bezel: 22.0 mm (0.87 inches)		

Chassis weight

Table 10. Dell EMC PowerEdge R240 system weight

System configuration	Maximum weight (with all drives/SSDs)
4 x 3.5-inch drives	12.2 kg (26.89 lb)

Video specifications

The Dell EMC PowerEdge R240 system supports integrated Matrox G200 graphics controller with 16 MB of video frame buffer.

Table 11. Supported video resolution options

Resolution	Refresh rate (Hz)	Color depth (bits)
640 x 480	60, 72	8, 16, 24
800 x 600	60, 75, 85	8, 16, 24
1024 x 768	60, 75, 85	8, 16, 24
1152 x 864	60, 75, 85	8, 16, 24
1280 x 1024	60, 75	8, 16, 24

USB ports specifications

Table 12. Dell EMC PowerEdge R240 system USB specifications

Front		Rear		Internal	
USB port type	No. of ports	USB port type	No. of ports	USB port type	No. of ports
USB 2.0-compliant port	One	USB 3.0-compliant ports	Two	Internal USB 3.0-compliant port	One
Micro USB 2.0-compliant port for iDRAC Direct	One				

 **NOTE:** The micro USB 2.0 compliant port can only be used as an iDRAC Direct or a management port.

Drives

The PowerEdge R240 system supports SAS, SATA drives and Solid State Drives (SSDs).

Drives:

- 4 x 3.5-inch hot-swappable SAS, SATA, or SSD
- 4 x 3.5-inch cabled drives
- 2 x 3.5-inch cabled drives

 **NOTE:** LED functionality is not supported on cabled hard disk drive configuration.

Backplane:

- Supports 4 x 3.5-inch and 4 x 2.5-inch SAS, SATA, or SSD drives passive backplane

- Up to 4 x 3.5-inch SAS, SATA, or SSD drives

NIC ports specifications

The Dell EMC PowerEdge R240 system supports up to two 10/100/1000 Mbps Network Interface Controller (NIC) ports that are located on the back panel.

Environmental specifications

NOTE: For additional information about environmental certifications, refer to the *Product Environmental Datasheet* located with the Manuals & Documents on www.dell.com/support/home.

Table 13. Temperature specifications

Temperature	Specifications
Storage	-40–65°C (-40–149°F)
Continuous operation (for altitude less than 950 m or 3117 ft)	10–35°C (50–95°F) with no direct sunlight on the equipment
Fresh air	For information about fresh air, see the Expanded operating temperature section.
Maximum temperature gradient (operating and storage)	20°C/h (68°F/h)

Table 14. Relative humidity specifications

Relative humidity	Specifications
Storage	5% to 95% RH with 33°C (91°F) maximum dew point. Atmosphere must be noncondensing at all times.
Operating	10% to 80% RH with 29°C (84.2°F) maximum dew point.

Table 15. Maximum vibration specifications

Maximum vibration	Specifications
Operating	0.26 G _{rms} at 5 Hz to 350 Hz (all operation orientations)
Storage	1.88 G _{rms} at 10 Hz to 500 Hz for 15 minutes (all six sides tested)

Table 16. Maximum shock pulse specifications

Maximum shock pulse	Specifications
Operating	Six consecutively executed shock pulses in the positive and negative x, y, and z axis of 6 G for up to 11 ms.
Storage	Six consecutively executed shock pulses in the positive and negative x, y, and z axis (one pulse on each side of the system) of 71 G for up to 2 ms.

Table 17. Maximum altitude specifications

Maximum altitude	Specifications
Operating	3048 m (10,000 ft)
Storage	12,000 m (39,370 ft)

Table 18. Operating temperature derating specifications

Operating temperature derating	Specifications
Up to 35°C (95°F)	Maximum temperature is reduced by 1°C/300 m (1°F/547 ft), above 950 m (3,117 ft).
35–40°C (95–104°F)	Maximum temperature is reduced by 1°C/175 m (1°F/319 ft), above 950 m (3,117 ft).
40–45°C (104–113°F)	Maximum temperature is reduced by 1°C/125 m (1°F/228 ft), above 950 m (3,117 ft).

Standard operating temperature

Table 19. Standard operating temperature specifications

Standard operating temperature	Specifications
Continuous operation (for altitude less than 950 m or 3117 ft)	10–35°C (50–95°F) with no direct sunlight on the equipment.

Expanded operating temperature

Table 20. Expanded operating temperature specifications

Expanded operating temperature	Specifications
Continuous operation	<p>5°C–40°C at 5% to 85% RH with 29°C dew point.</p> <p>NOTE: Outside the standard operating temperature (10°C–35°C), the system can operate continuously in temperatures as low as 5°C and as high as 40°C.</p> <p>For temperatures 35°C– 40°C, derate maximum allowable temperature by 1°C per 175 m (1°F per 319 ft) above 950 m (3,117 ft).</p>
≤ 1% of annual operating hours	<p>-5°C–45°C at 5% to 90% RH with 29°C dew point.</p> <p>NOTE: Outside the standard operating temperature (10°C–35°C), the system can operate down to -5°C or up to 45°C for a maximum of 1% of its annual operating hours.</p> <p>For temperatures 40°C– 45°C, derate maximum allowable temperature by 1°C per 125 m (1°F per 228 ft) above 950 m (3,117 ft).</p>

NOTE: When operating in the expanded temperature range, the performance of the system may be impacted.

NOTE: When operating in the expanded temperature range, ambient temperature warnings may be reported on the System Event Log.

Expanded operating temperature restrictions

- Do not perform a cold startup of the system below 5°C.
- The operating temperature specified is for a maximum altitude of 950m for fresh air cooling.
- Four system fans are required.
- Support for up to 71W processor.
- GPU is not supported.
- Non-Dell qualified peripheral cards and/or peripheral cards greater than 25 W are not supported.

Particulate and gaseous contamination specifications

The following table defines the limitations that help avoid any damages to the IT equipment and/or, or both failure from particulate and gaseous contamination. If the levels of particulate or gaseous pollution exceed the specified limitations and results in equipment damage or failure, you must rectify the environmental conditions. Remediation of environmental conditions is the responsibility of the customer.

Table 21. Particulate contamination specifications

Particulate contamination	Specifications
Air filtration	<p>Data center air filtration as defined by ISO Class 8 per ISO 14644-1 with a 95% upper confidence limit.</p> <p>i NOTE: This condition applies to data center environments only. Air filtration requirements do not apply to IT equipment designed to be used outside a data center, in environments such as an office or factory floor.</p> <p>i NOTE: Air entering the data center must have MERV11 or MERV13 filtration.</p>
Conductive dust	<p>Air must be free of conductive dust, zinc whiskers, or other conductive particles.</p> <p>i NOTE: This condition applies to data center and non-data center environments.</p>
Corrosive dust	<ul style="list-style-type: none"> Air must be free of corrosive dust. Residual dust present in the air must have a deliquescent point less than 60% relative humidity. <p>i NOTE: This condition applies to data center and non-data center environments.</p>

Table 22. Gaseous contamination specifications

Gaseous contamination	Specifications
Copper Coupon Corrosion	<300 Å/month per Class G1 as defined by ANSI/ISA71.04-1985.
Silver Coupon Corrosion	<200 Å/month as defined by AHSRAE TC9.9.

i **NOTE:** Maximum corrosive contaminant levels measured at ≤50% relative humidity.

Appendix B. Standards compliance

Table 23. Industry standard documents

Standard	URL for information and specifications
ACPI Advance Configuration and Power Interface Specification, v2.0c	acpi.info
Ethernet IEEE 802.3-2005	standards.ieee.org/getieee802/802.3.html
HDG Hardware Design Guide Version 3.0 for Microsoft Windows Server	microsoft.com/whdc/system/platform/pcdesign/desguide/serverdg.mspx
IPMI Intelligent Platform Management Interface, v2.0	intel.com/design/servers/ipmi
DDR4 Memory DDR4 SDRAM Specification	jedec.org/standards-documents/docs/jesd79-4.pdf
PCI Express PCI Express Base Specification Rev. 2.0 and 3.0	pcisig.com/specifications/pciexpress
PMBus Power System Management Protocol Specification, v1.2	pmbus.info/specs.html
SAS Serial Attached SCSI, v1.1	t10.org
SATA Serial ATA Rev. 2.6; SATA II, SATA 1.0a Extensions, Rev. 1.2	sata-io.org
SMBIOS System Management BIOS Reference Specification, v2.7	dmtf.org/standards/smbios
TPM Trusted Platform Module Specification, v1.2 and v2.0	trustedcomputinggroup.org
UEFI Unified Extensible Firmware Interface Specification, v2.1	uefi.org/specifications
USB Universal Serial Bus Specification, Rev. 2.0	usb.org/developers/docs

Appendix C Additional resources

Table 24. Additional resources

Resource	Description of contents	Location
Installation and Service Manual	<p>This manual, available in PDF format, provides the following information:</p> <ul style="list-style-type: none"> • Chassis features • System Setup program • System messages • System codes and indicators • System BIOS • Remove and replace procedures • Troubleshooting • Diagnostics • Jumpers and connectors 	Dell.com/Support/Manuals
Getting Started Guide	<p>This guide ships with the system, and is also available in PDF format. This guide provides the following information:</p> <ul style="list-style-type: none"> • Initial setup steps • Key system features • Technical specifications 	Dell.com/Support/Manuals
Rack Installation Instructions	This document ships with the rack kits, and provides instructions for installing a server in a rack.	Dell.com/Support/Manuals
Information Update	This document ships with the system, is also available in PDF format online, and provides information on system updates.	Dell.com/Support/Manuals
System Information Label	The system information label documents the system board layout and system jumper settings. Text is minimized due to space limitations and translation considerations. The label size is standardized across platforms.	Inside the system chassis cover
Quick Resource Locator (QRL)	This code on the chassis can be scanned by a phone application to access additional information and resources for the server, including videos, reference materials, service tag information, and Dell EMC contact information.	Inside the system chassis cover
Energy Smart Solution Advisor (ESSA)	The Dell EMC online ESSA enables easier and more meaningful estimates to help you determine the most efficient configuration possible. Use ESSA to calculate the power consumption of your hardware, power infrastructure, and storage.	Dell.com/calc

Appendix D. Support and deployment services

Topics:

- Dell EMC ProDeploy Enterprise Suite
- Deployment services
- Dell EMC Remote Consulting Services
- Dell EMC Data Migration Service
- ProSupport Enterprise Suite
- ProSupport Plus
- ProSupport
- ProSupport One for Data Center
- Support Technologies
- Additional professional services
- Dell Education Services
- Dell EMC Global Infrastructure Consulting Services
- Dell EMC Managed Services

Dell EMC ProDeploy Enterprise Suite

ProDeploy Enterprise Suite gets your server out of the box and into optimized production—fast. Our elite deployment engineers with broad and deep experience utilizing best-in-class processes along with our established global scale can help you around the clock and around the globe. From simple to the most complex server installations and software integration, we take the guess work and risk out of deploying your new server technology.

		Basic Deployment	ProDeploy	ProDeploy Plus
Pre-deployment	Single point of contact for project management	-	●	In-region
	Site readiness review	-	●	●
	Implementation planning	-	●	●
	SAM engagement for ProSupport Plus entitled devices	-	-	●
Deployment	Deployment service hours	Business hours	24x7	24x7
	Remote guidance for hardware installation or Onsite hardware installation and packaging material removal	Onsite	Remote or Onsite	Onsite
	Install and configure system software	-	Remote	Onsite
	Install support software and connect with Dell Technologies	-	●	●
	Project documentation with knowledge transfer	-	●	●
Post-deployment	Deployment verification	-	●	●
	Configuration data transfer to Dell EMC technical support	-	●	●
	30-days of post-deployment configuration assistance	-	-	●
	Training credits for Dell EMC Education Services	-	-	●

Figure 10. ProDeploy Enterprise Suite capabilities

 **NOTE:** Hardware installation not applicable on selected software products.

Dell EMC ProDeploy Plus

From beginning to end, ProDeploy Plus provides the skill and scale needed to successfully execute demanding deployments in today's complex IT environments. Certified Dell EMC experts start with extensive environmental assessments and detailed migration planning and recommendations. Software installation includes set up of most versions of Dell EMC SupportAssist and OpenManage system management utilities. Post-deployment configuration assistance, testing, and product orientation services are also available.

Dell EMC ProDeploy

ProDeploy provides full service installation and configuration of both server hardware and system software by certified deployment engineers including set up of leading operating systems and hypervisors as well as most versions of Dell EMC SupportAssist and OpenManage system management utilities. To prepare for the deployment, we conduct a site readiness review and implementation planning exercise. System testing, validation, and full project documentation with knowledge transfer complete the process.

Dell EMC Basic Deployment

Basic Deployment delivers worry-free professional installation by experienced technicians who know Dell EMC servers inside and out.

Dell EMC Residency Services

Residency Services helps customers transition to new capabilities quickly with the assistance of on-site or remote Dell EMC experts whose priorities and time you control. Residency experts can provide post implementation management and knowledge transfer related to a new technology acquisition or day-to-day operational management of the IT infrastructure.

Deployment services

Deployment services details and exceptions can be found in service description documents at the Enterprise Configuration and Deployment page on Dell.com.

Dell EMC Remote Consulting Services

When you are in the final stages of your PowerEdge server implementation, you can rely on Dell EMC Remote Consulting Services and our certified technical experts to help you optimize your configuration with best practices for your software, virtualization, server, storage, networking, and systems management.

Dell EMC Data Migration Service

Protect your business and data with our single point of contact to manage your data migration project. Your project manager will work with our experienced team of experts to create a plan using industry-leading tools and proven processes based on global best practices to migrate your existing files and data so your business system get up and running quickly and smoothly.

ProSupport Enterprise Suite

With the ProSupport Enterprise Suite, we can help you keep your operation running smoothly, so you can focus on running your business. We will help you maintain peak performance and availability of your most essential workloads. ProSupport Enterprise Suite is a suite of support services that enable you to build the solution that is right for your organization. Choose support models based on how you use technology and where you want to allocate resources. From the desktop to the data center, address everyday IT challenges, such as unplanned downtime, mission-critical needs, data and asset protection, support

planning, resource allocation, software application management and more. Optimize your IT resources by choosing the right support model.



Figure 11. ProSupport Enterprise Suite

ProSupport Plus

When you purchase PowerEdge servers, we recommend ProSupport Plus, our proactive and preventative support, for business-critical systems. ProSupport Plus provides all the benefits of ProSupport, plus the following:

- An assigned Services Account Manager (SAM) who knows your business and your environment
- Access to senior ProSupport engineers for faster issue resolution
- Personalized, preventive recommendations based on analysis of support trends and best practices from across the Dell EMC customer base to reduce support issues and improve performance
- Predictive analysis for issue prevention and optimization enabled by SupportAssist
- Proactive monitoring, issue detection, notification and automated case creation for accelerated issue resolution enabled by SupportAssist
- On-demand reporting and analytics-based recommendations enabled by SupportAssist and TechDirect

ProSupport

Our ProSupport service offers highly trained experts around the clock and around the globe to address your IT needs. We will help you minimize disruptions and maximize availability of your PowerEdge server workloads with:

- 24x7x365 access to certified hardware and software experts
- Collaborative 3rd party support
- Hypervisor and OS support
- Consistent level of support available for Dell EMC hardware, software and solutions
- Onsite parts and labor response options including next business day or four-hour mission critical

ProSupport One for Data Center

ProSupport One for Data Center offers flexible site-wide support for large and distributed data centers with more than 1,000 assets. This offering is built on standard ProSupport components that leverage our global scale but are tailored to your company's needs. While not for everyone, it offers a truly unique solution for Dell EMC's largest customers with the most complex environments.

- Team of assigned Services Account Managers (SAM) with remote, on-site options
- Assigned ProSupport One technical and field engineers who are trained on your environment and configurations
- On-demand reporting and analytics-based recommendations enabled by SupportAssist and TechDirect
- Flexible on-site support and parts options that fit your operational model
- A tailored support plan and training for your operations staff

Enterprise Support Services

Feature Comparison

	ProSupport	ProSupport Plus	ProSupport One for Data Center
Remote technical support	24x7	24x7	24x7
Onsite support	Next business day or Mission Critical	Next business day or Mission Critical	Flexible
Automated issue detection and case creation	●	●	●
Self-service case initiation and management	●	●	●
Hypervisor, Operating Environment Software and OS support	●	●	●
Priority access to specialized support experts		●	●
Designated Technology Service Manager		●	●
Personalized assessments and recommendations		●	●
On-demand support and utilization reports		●	●
Systems Maintenance guidance		Semiannual	Optional
Designated technical and field support teams			●

Figure 12. ProSupport One for Data Center model

Support Technologies

Powering your support experience with predictive, data-driven technologies.

SupportAssist

The best time to solve a problem is before it happens. The automated proactive and predictive technology SupportAssist* helps reduce steps and time to resolution, often detecting issues before they become a crisis. Benefits include:

- Value - SupportAssist is available to all customers at no additional charge.
- Improve productivity - replace manual, high-effort routines with automated support.
- Accelerate time to resolution - receive issue alerts, automatic case creation and proactive contact from Dell EMC experts.
- Gain insight and control - optimize enterprise devices with on-demand ProSupport Plus reporting in TechDirect and get predictive issue detection before the problem starts.

SupportAssist is included with all support plans but features vary based on service level agreement.

	Basic Hardware Warranty	ProSupport	ProSupport Plus
Automated issue detection and system state information collection	•	•	•
Proactive, automated case creation and notification		•	•
Predictive issue detection for failure prevention			•
Recommendation reporting available on-demand in TechDirect			•

Figure 13. SupportAssist model

Get started at Dell.com/SupportAssist

TechDirect

Boost your IT teams productivity when supporting Dell EMC systems. With over 1.4 million self-dispatches processed each year, TechDirect has proven its effectiveness as a support tool. You can:

- Self-dispatch replacement parts
- Request technical support
- Integrate APIs into your help desk

Or, access all your Dell EMC certification and authorization needs. Train your staff on Dell EMC products as TechDirect allows you to:

- Download study guides
- Schedule certification and authorization exams
- View transcripts of completed courses and exams

Register at techdirect.dell.com

Additional professional services

Dell Education Services

Dell Education Services offers the PowerEdge server training courses designed to help you achieve more with your hardware investment. The curriculum is designed in conjunction with the server development team, as well as Dell EMC's technical support team, to ensure that the training delivers the information and practical, hands-on skills you and your team need to confidently manage and maintain your Dell EMC server solution. To learn more or register for a class today, visit LearnDell.com/Server.

Dell EMC Global Infrastructure Consulting Services

Dell EMC Global Infrastructure Consulting Services use skilled solution architects, innovative tools, automated analysis and Dell EMC's intellectual property to give rapid insight into the root causes of unnecessary complexity. We seek better answers than traditional service models, and our strategy is to help quickly identify high-impact, short-duration projects that deliver return on investment (ROI) and free up resources. The results are practical, action-oriented plans with specific, predictable, measurable outcomes. From data center optimization to server virtualization to systems management, our consulting services can help build a more efficient enterprise.

Dell EMC Managed Services

Dell EMC Managed Services are a modular set of lifecycle services designed to help you automate and centrally configure, deploy, and manage your day-to-day data center operations. These services extend your existing on-premise IT infrastructure with off-premise cloud services designed to better address challenges with mobility, highly distributed organizations, security, compliance, business continuity, and disaster preparedness.