



Dell PowerVault MD3060e Storage Enclosure Owner's Manual

Regulatory Model: E08J Series
Regulatory Type: E08J001



Notes, Cautions, and Warnings

-  **NOTE:** A NOTE indicates important information that helps you make better use of your computer.
-  **CAUTION:** A CAUTION indicates either potential damage to hardware or loss of data and tells you how to avoid the problem.
-  **WARNING:** A WARNING indicates a potential for property damage, personal injury, or death.

© 2016 Dell Inc. All rights reserved. This product is protected by U.S. and international copyright and intellectual property laws. Dell and the Dell logo are trademarks of Dell Inc. in the United States and/or other jurisdictions. All other marks and names mentioned herein may be trademarks of their respective companies.

2016 - 05

Rev. A02

Contents

1 About your system.....	5
Introduction.....	5
Front-Panel Features	5
Front-Panel Indicators	6
Back-Panel Features.....	8
Cooling Fan Module LED Indicator Codes.....	9
Power Supply Module Features And Indicators	10
Physical Disk Installation Guidelines.....	11
Enclosure Management Module.....	12
MD3060e Enclosure Management Module Features And Indicators.....	12
Storage Enclosure Thermal Shutdown.....	13
Related Documentation.....	13
2 Installing and removing system components.....	15
Recommended Tools.....	15
Removing And Installing The Front Bezel.....	15
Installing The Front Bezel.....	15
Removing The Front Bezel.....	16
Service Action Allowed Indicator LED.....	16
Physical-Disk Drawers.....	16
Opening The Physical-Disk Drawer.....	17
Closing The Physical-Disk Drawer.....	18
Removing The Physical-Disk Drawer.....	19
Installing The Physical-Disk Drawer.....	20
Physical Disks.....	21
Removing A Physical Disk From A Physical-Disk Carrier.....	21
Installing A Physical Disk In A Physical-Disk Carrier.....	23
Removing A Physical Disk From A Physical-Disk Drawer.....	24
Installing A Physical Disk In A Physical-Disk Drawer.....	25
SAS Chain Cables.....	25
Removing The SAS Chain Cable(s).....	26
Installing The SAS Chain Cable(s).....	27
Enclosure Management Modules.....	28
Removing An Enclosure Management Module.....	28
Installing An Enclosure Management Module.....	29
Power Supplies.....	29
Removing A Power Supply Module.....	30
Installing A Power Supply Module.....	31

Cooling Fan Modules.....	32
Removing A Cooling Fan Module.....	32
Installing A Cooling Fan Module.....	33
3 Troubleshooting your system.....	34
Safety first—for you and your system.....	34
Troubleshooting External Connections.....	34
Troubleshooting Power Supply Modules.....	34
Troubleshooting Enclosure Cooling Problems.....	35
Troubleshooting Physical Disks.....	35
Troubleshooting A Wet Storage Enclosure.....	36
4 Technical Specifications.....	37
5 Getting help.....	40
Locating your system service tag.....	40
Contacting Dell.....	40
Documentation feedback.....	40

About your system

Introduction

CAUTION: See the **Safety, Environmental, and Regulatory Information** document for important safety information before following any procedures listed in this document.

The MD3060e storage enclosure is a 4U rack-mounted system, capable of accommodating up to sixty 3.5 inch or 2.5 inch physical disks.

This document familiarizes you with the functions of the Dell PowerVault MD3060e storage enclosure. The document is organized according to the tasks that you must complete after receiving your storage enclosure.

Front-Panel Features

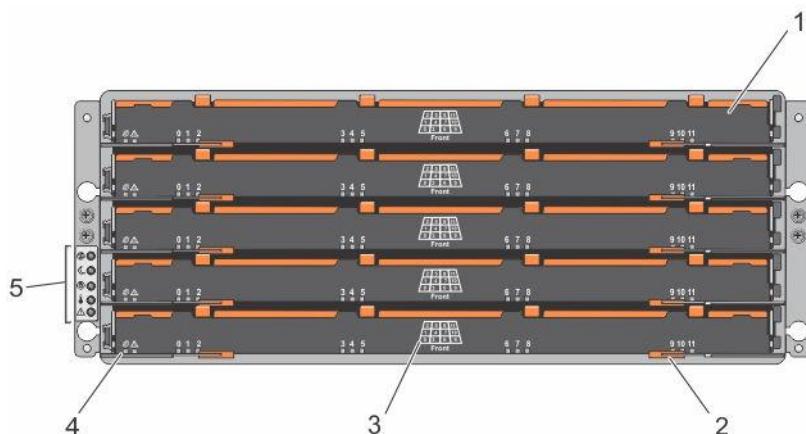

Figure 1. Front-Panel Features

- | | |
|---------------------------------|--|
| 1. drawers (5) | 2. drawer release latches (2 per drawer) |
| 3. physical disk slot numbering | 4. drawer indicator LEDs |
| 5. front-panel indicators | |

Front-Panel Indicators

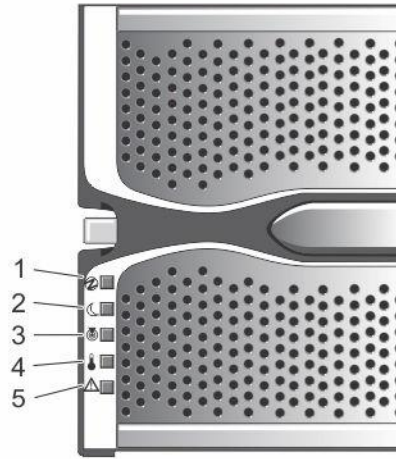

Figure 2. Front-Bezel Indicators

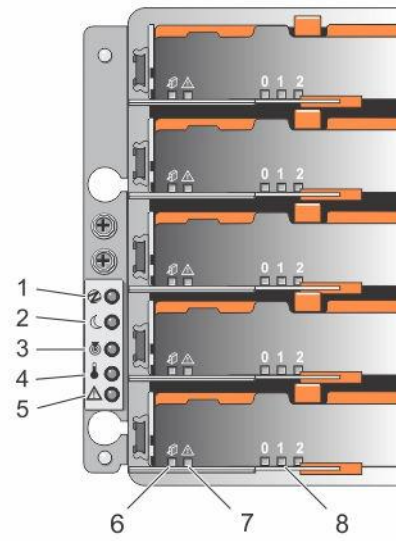











Figure 3. Front-Panel Indicators

Item	Indicator	Icon	Description
1	Power-on indicator		The power-on indicator lights green when at least one power supply module is supplying power to the storage enclosure.
2	Standby power indicator		The standby power indicator lights green when the system is in standby mode and the main power is off.
3	System identification indicator		The system identification indicator lights white and helps locate a particular enclosure within a rack.
4	Over temperature indicator		The over temperature indicator lights amber when the temperature of the system has reached an unsafe condition.
5	Service action required indicator (system)		The Service action required indicator lights amber when there is a fault in one of the components in the system.
6	Service action allowed indicator (system)		<p> CAUTION: Remove the physical disk drawer from the system only if the Service action allowed indicator lights blue. Removing the physical disk drawer from the system when the Service action allowed indicator is off may damage the system.</p> <p> NOTE: The Service action allowed indicator LED is not used in server attached configurations.</p> <p>Blue Indicates that you can safely remove the physical disk drawer from the system.</p> <p>Off Indicates that you cannot remove the physical disk drawer from the system.</p>
7	Service action required indicator (drawer)		<p>Amber Indicates that the cable is attached and at least one lane has a link up status, but at least one lane has a link down status.</p> <p>Off Indicates that:</p> <ul style="list-style-type: none"> • No cable is attached. • A cable is attached, and all lanes have a link up status.

Item	Indicator	Icon	Description
			<ul style="list-style-type: none"> A cable is attached, and all lanes have a link down status.
8	Drive activity indicator		<p>NOTE: The associated physical disk is indicated by a number (0 to 11) that is displayed above the drive activity indicator. For example, for physical disk 2 on the physical disk drawer, the drive activity indicator has 2 displayed above the drive activity indicator.</p> <p>Green Indicates that power is on and the physical disk is operating normally.</p> <p>Blinks green Indicates I/O activity for that physical disk.</p> <p>Off Indicates that there is no power reaching the drive or a drive is not installed.</p>

Back-Panel Features

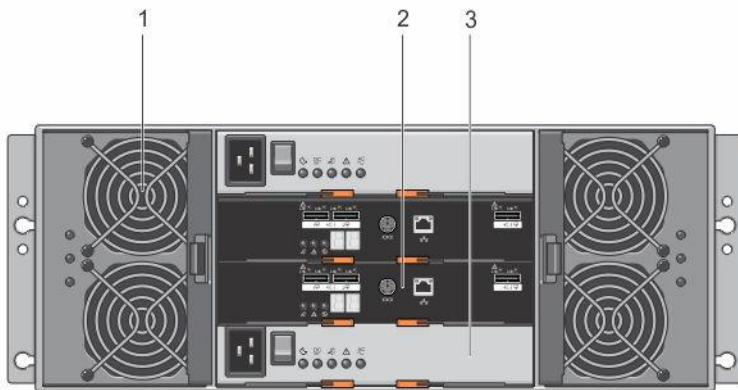

Figure 4. Back-Panel Features

1. cooling fan modules (2)
2. enclosure management modules (2)
3. power supply modules (2)

Cooling Fan Module LED Indicator Codes

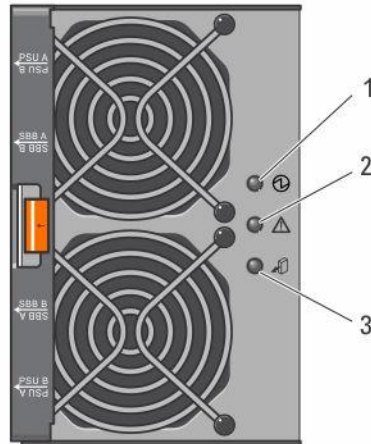

Figure 5. Cooling Fan Module Indicators

Item	Indicator	Icon	Description
1	Power indicator		The power indicator lights green when power to the cooling fan module is available.
2	Service action required indicator		The Service action required indicator lights amber when there is a fault in the cooling fan module.
3	Service action allowed indicator		<p> CAUTION: Remove the cooling fan module from the system only if the Service action allowed indicator lights blue. Removing the cooling fan module from the system when the Service action allowed indicator is off may damage the system.</p> <p> NOTE: The Service action allowed indicator LED is not used in server attached configurations.</p> <p>Blue Indicates that you can safely remove the cooling fan module from the system.</p> <p>Off Indicates that you cannot remove the cooling fan module from the system.</p>

Power Supply Module Features And Indicators

NOTE: Your storage enclosure is shipped with two IEC C19 to C20 jumper cords. Connect the C19 plug to the enclosure's power supplies and the C20 plug to the power distribution unit (PDU) in the rack cabinet.

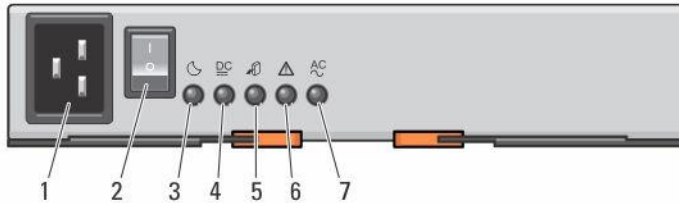







Figure 6. Power Supply Module Features and Status Indicators

Item	Indicator or Connector	Icon	Description
1	Power connector		Connect the external power supply source to this connector.
2	Power switch		The power switch controls the power supply output to the system.
3	Standby power indicator		The standby power indicator lights green when the system is in standby mode and the main power is off.
4	DC power indicator		Green Indicates that DC output voltage is within the limit.
			Off Indicates that DC output voltage is not within the limit.
5	Service action allowed indicator		CAUTION: Remove the power supply module from the system only if the Service action allowed indicator lights blue. Removing the power supply module from the system when the Service action allowed indicator is off may damage the system.
			NOTE: The Service action allowed indicator LED is not used in server attached configurations.
			Blue Indicates that you can safely remove the power

Item	Indicator or Connector	Icon	Description
			supply module from the system.
			Off Indicates that you cannot remove the power supply module from the system.
6	Service action required indicator		The service action required indicator lights amber when there is a fault in the power supply module.
7	AC power indicator		Green Indicates that AC output voltage is within the limit.
			Off Indicates that AC output voltage is not within the limit.

Physical Disk Installation Guidelines

To maintain proper airflow, install physical disks from left to right and front to back in each drawer. The following table lists the slot numbers of the physical disks and the order in which the disks need to be installed.

Physical Disk Installation Order	Slot Number
1	0
2	3
3	6
4	9
5	1
6	4
7	7
8	10
9	2
10	5
11	8
12	11

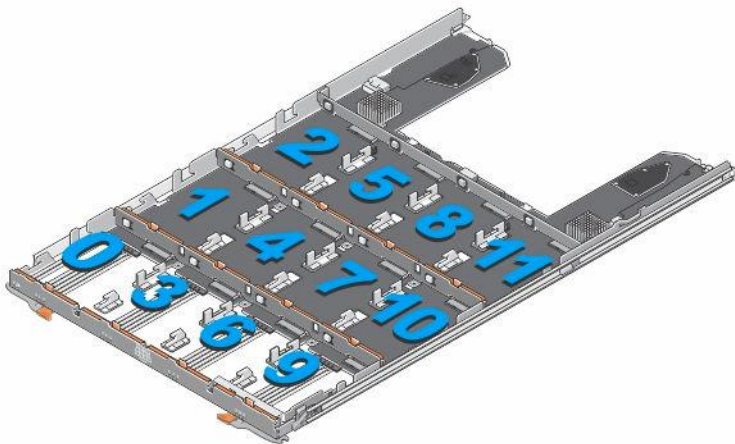

Figure 7. Slot Numbering on the Disk Drawer

NOTE: If you need to install less than 12 physical disks, you must follow the recommended physical disk installation order. For example if you have to install only 7 disks, the order of installation should be 0, 3, 6, 9, 1, 4, and 7.

- A minimum of four disks must be installed in the front slots 0, 3, 6, and 9 of each drawer.
- The MD3060e storage enclosure supports mixing of physical disk types.

NOTE: 3.5" 10k and 15k RPM SAS drives are not supported. For the latest drive support, refer to *Dell Enclosure Storage Support Matrix* at: Dell.com/powervaultmanuals.

Enclosure Management Module

Use the enclosure management modules to expand the storage capacity, by daisy-chaining your storage enclosure with additional MD3060e storage enclosures.

NOTE: Hot-plug of MD3060e storage enclosure is not supported.

MD3060e Enclosure Management Module Features And Indicators

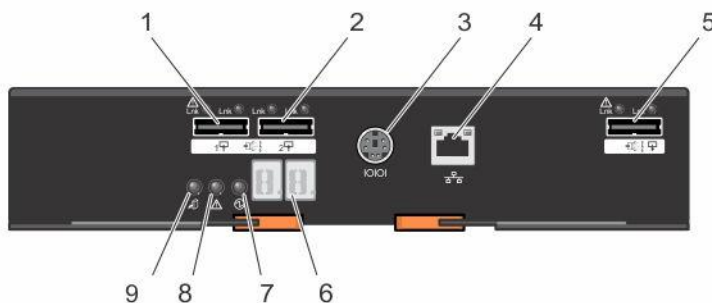









Figure 8. MD3060e Enclosure Management Module Features and Indicators

Item	Indicator, Button, or Connector	Icon	Description
1	SAS IN port 0		For SAS connection of the storage enclosure to a server, RAID controller, or another storage enclosure.
2	SAS IN port 1		For SAS connection of the storage enclosure to a server, RAID controller, or another storage enclosure.
3	Serial debug port		Dell support only.
4	Telnet port		Dell support only.
5	SAS OUT port		For connection to additional storage enclosures.
6	Diagnostic LED		The numeric display consists of two seven-segment LEDs that provide information about enclosure identification and diagnostics.
7	Module power indicator		The module power indicator lights green when module power is on.
8	Service action required indicator (system)		The Service action required indicator lights amber when there is a fault in one of the components in the system.
9	Service action allowed indicator		<p> CAUTION: Remove the expansion module from the system only if the Service action allowed indicator lights blue. Removing the expansion module from the system when the Service action allowed indicator is off may damage the system.</p> <p> NOTE: The Service action allowed indicator LED is not used in server attached configurations.</p> <p>Blue Indicates that you can safely remove the expansion module from the system.</p> <p>Off Indicates that you cannot remove the expansion module from the system.</p>



Storage Enclosure Thermal Shutdown

The system automatically shuts down when system temperature exceeds the safe threshold.

Temperature threshold values determine the temperature at which shutdown occurs. These thresholds cannot be changed. The system will attempt to auto-restart after returning to normal temperatures.

Related Documentation

 **WARNING: See the safety and regulatory information that shipped with your system. Warranty information may be included within this document or as a separate document.**

-  **NOTE:** For all PowerVault documentation, go to dell.com/powervaultmanuals and enter the system Service Tag to get your system documentation.
- Rack Installation Instructions — Describes how to install your system into a rack. This document is also shipped with your rack solution.
 - *Dell PowerVault MD3060e Storage Enclosure Deployment Guide* — Provides information about deploying the storage system in the direct attached architecture.
 - *Dell Storage Enclosure Support Matrix* — Provides information about the software and hardware compatibility matrices for the storage enclosure.
-  **NOTE:** For the latest documentation updates, check dell.com/support/manuals.
-  **NOTE:** When upgrading your system, it is recommended that you download and install the latest BIOS, drivers, and systems management firmware on your system from Dell.com/support.

Installing and removing system components

Recommended Tools

You may need the following items to perform the procedures in this section:

- #2 Phillips screwdriver
- T8 and T15 Torx screwdrivers
- Wrist grounding strap connected to ground

Removing And Installing The Front Bezel

Installing The Front Bezel

You must install the front bezel on the system to secure the disk drawers against accidental removal.

1. Align the slots on the back of the bezel with the guide pins on the front of the chassis.
2. Push the bezel toward the chassis until the bezel is seated properly and the release latches snap into place.

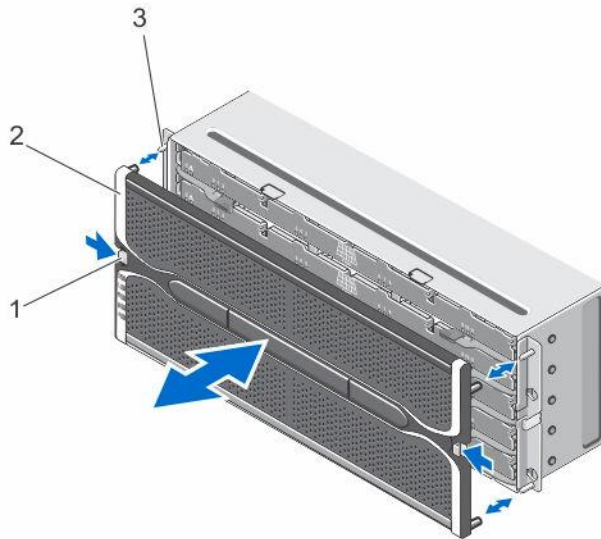

Figure 9. Removing and Installing the Front Bezel

1. release latches (2)
2. front bezel
3. guide pins (4)

Removing The Front Bezel

You must remove the front bezel to access the disk drawers, which enables you to remove and install physical disks in the system.

1. Press the release latch on either side of the front bezel.
2. Keeping the release latches pressed, hold the bezel and pull the bezel away from the system.

Service Action Allowed Indicator LED

Each hot-swappable component on your storage enclosure has a Service action allowed indicator. The Service action allowed indicator, indicates that a component can be safely removed from the storage enclosure.

⚠ CAUTION: Never remove any hot-swappable component until the Service action allowed indicator on the component lights blue. Removing a hot-swappable component with the Service action allowed indicator off, can result in a loss of data and data availability.

📝 NOTE: The Service action allowed indicator LED is not used in server attached configurations.

Physical-Disk Drawers

Each storage array contains five physical-disk drawers. Each physical-disk drawer supports up to 12 hot-swappable physical disks.

📝 NOTE: You can open only one physical-disk drawer at a time. If you attempt to open more than one drawer, it may cause unexpected results.

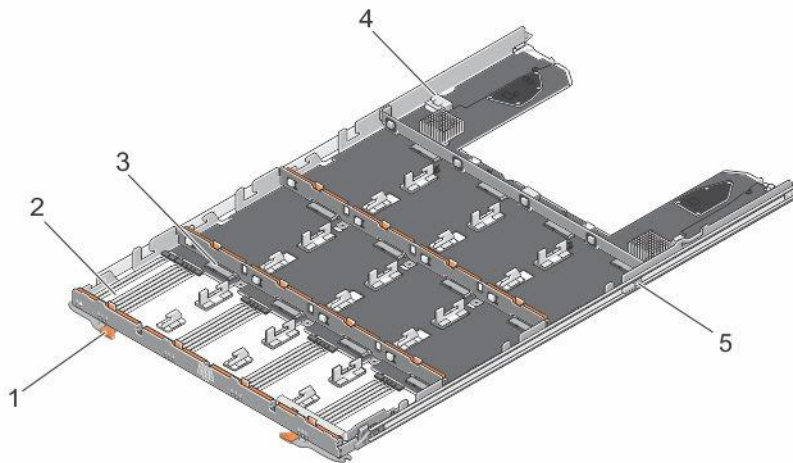

Figure 10. Inside the Physical-Disk Drawer

- | | |
|---|-----------------------------|
| 1. release latch (2) | 2. physical-disk bay (12) |
| 3. physical-disk connector (12) | 4. SAS cable connection (2) |
| 5. physical-disk drawer release tab (2) | |

Opening The Physical-Disk Drawer

⚠ CAUTION: Many repairs may only be done by a certified service technician. You should only perform troubleshooting and simple repairs as authorized in your product documentation, or as directed by the online or telephone service and support team. Damage due to servicing that is not authorized by Dell is not covered by your warranty. Read and follow the safety instructions that came with the product.

1. Remove the front bezel.
2. Hold and rotate the release latches away from the system until the physical-disk drawer is free from its slot.
3. Hold the physical-disk drawer and pull it away from the chassis.

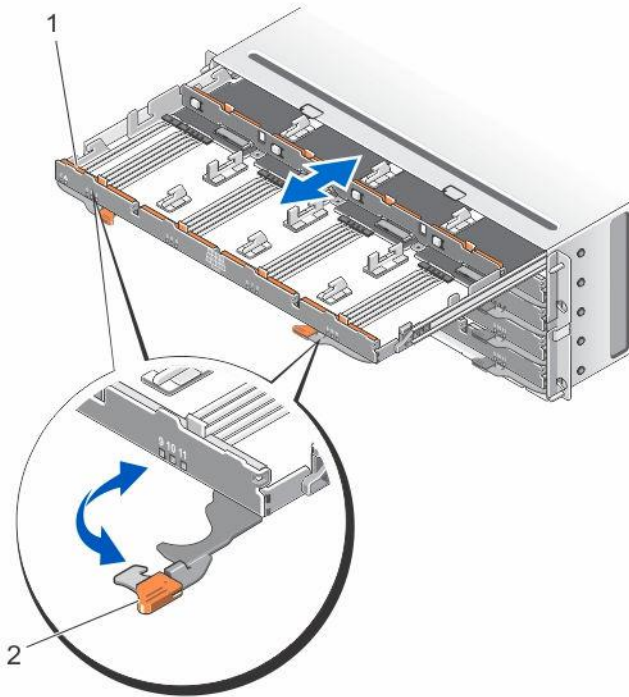

Figure 11. Opening and Closing the Physical-Disk Drawer

1. physical-disk drawer
2. release latches (2)

Closing The Physical-Disk Drawer

⚠ CAUTION: Many repairs may only be done by a certified service technician. You should only perform troubleshooting and simple repairs as authorized in your product documentation, or as directed by the online or telephone service and support team. Damage due to servicing that is not authorized by Dell is not covered by your warranty. Read and follow the safety instructions that came with the product.

1. Hold the physical-disk drawer and push it into the chassis until it is seated properly.
2. Hold and rotate the release latches toward the system until the release latches lock into place.
3. Install the front bezel.

Removing The Physical-Disk Drawer

 **CAUTION:** Many repairs may only be done by a certified service technician. You should only perform troubleshooting and simple repairs as authorized in your product documentation, or as directed by the online or telephone service and support team. Damage due to servicing that is not authorized by Dell is not covered by your warranty. Read and follow the safety instructions that came with the product.

1. Prepare the physical-disk drawer for removal by stopping all input and output to the storage enclosure.
2. Remove the front bezel.
3. Remove both the SAS cable chains from the back of the chassis.
4. Open the physical-disk drawer.

 **CAUTION:** Do not try to remove more than one drawer at a time. Ensure that you insert the drawer that is out completely before pulling out another drawer.

 **NOTE:** Note and save the location of the physical disks before removing the physical disks from the physical-disk drawer.

 **NOTE:** The physical-disk drawers are not hot-swappable. Replacing a physical-disk drawer causes all of the physical disks in the replaced drawer to be unavailable to the Enclosure Management Modules (EMM) in the storage subsystem.

5. Remove all the physical disks from the disk drawer.
6. Slide the physical-disk drawer out until the release tab on each side of the disk drawer is visible.
7. Pull the release tab toward the front of the system to release the physical-disk drawer from the chassis and pull the physical-disk drawer out of the chassis.

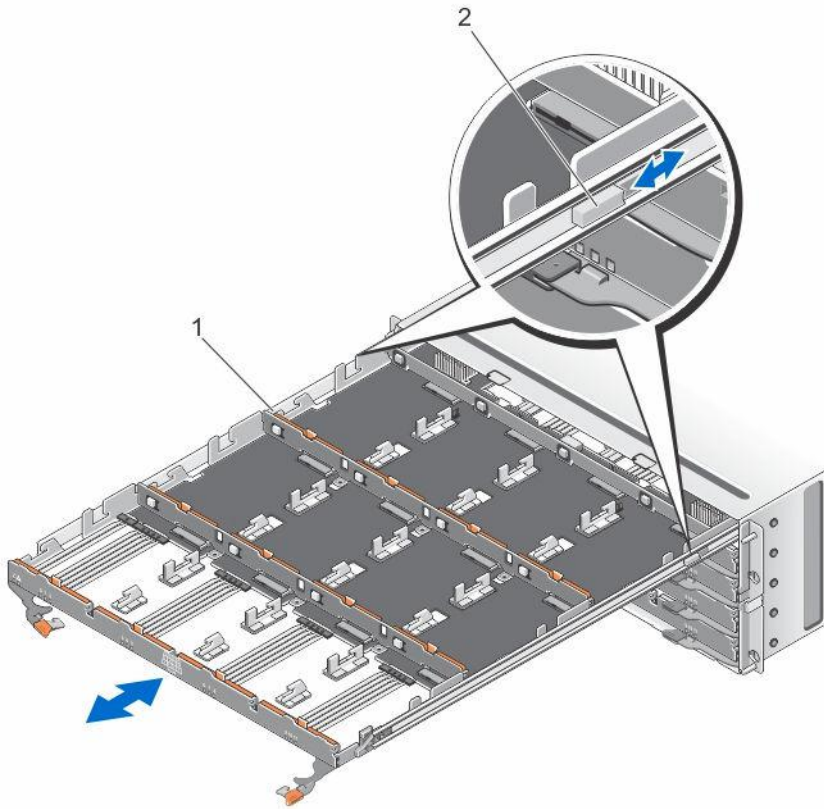

Figure 12. Removing and Installing the Physical-Disk Drawer

1. physical-disk drawer
2. release tabs (2)

Installing The Physical-Disk Drawer

⚠ CAUTION: Many repairs may only be done by a certified service technician. You should only perform troubleshooting and simple repairs as authorized in your product documentation, or as directed by the online or telephone service and support team. Damage due to servicing that is not authorized by Dell is not covered by your warranty. Read and follow the safety instructions that came with the product.

1. Align the physical-disk drawer with the slot on the chassis.
2. Slide the physical-disk drawer into the chassis until it is seated properly and the release tabs snap into place.
3. Install the physical disks row wise into the physical-disk drawer.
 - 🔧 NOTE:** Using the note that you saved while removing the physical-disk drawer, install the physical disks to the same location in the physical-disk drawer that they were in.
4. Close the physical-disk drawer.
5. Install the SAS chain cables.
 - 🔧 NOTE:** Make sure all the SAS chain cables are firmly connected to all the drawers.

6. Install the front bezel.

Physical Disks

Your system supports up to sixty 2.5 inch or 3.5 inch SAS and nearline SAS physical disks and up to 25 2.5 inch SAS SSDs per enclosure.

 **NOTE:** For more details on the latest supported physical disks, physical disk types, and supported quantities, see the *Dell Storage Enclosure Support Matrix*.

Removing A Physical Disk From A Physical-Disk Carrier

 **CAUTION:** Many repairs may only be done by a certified service technician. You should only perform troubleshooting and simple repairs as authorized in your product documentation, or as directed by the online or telephone service and support team. Damage due to servicing that is not authorized by Dell is not covered by your warranty. Read and follow the safety instructions that came with the product.

1. Pull the edge of the physical-disk carrier away from the physical disk until the pins on the physical-disk carrier disengage from the slots on one side of the physical-disk.
2. Hold the physical disk and angle the physical disk out of the physical-disk carrier.

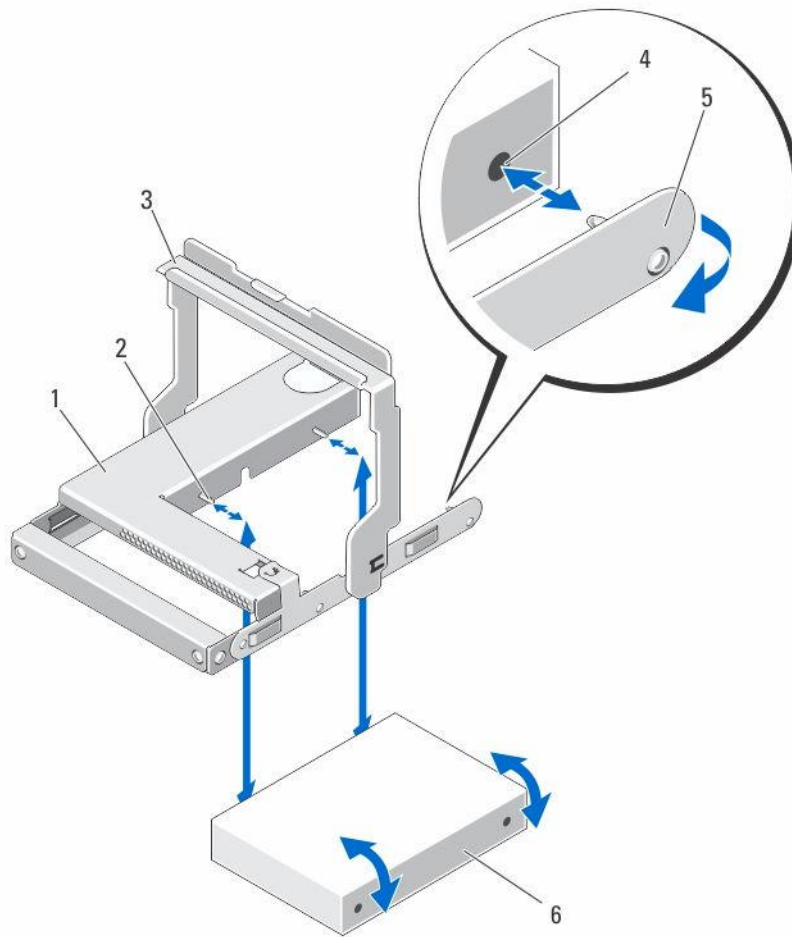

Figure 13. Removing and Installing the 2.5 Inch Physical Disk in a 2.5 Inch Physical-Disk Carrier

- | | |
|---------------------------------------|-------------------------------|
| 1. 2.5 inch physical drive cage | 2. guide pins (4) |
| 3. release handle | 4. holes on physical disk (4) |
| 5. carrier for 2.5 inch physical disk | 6. 2.5 inch physical disk |

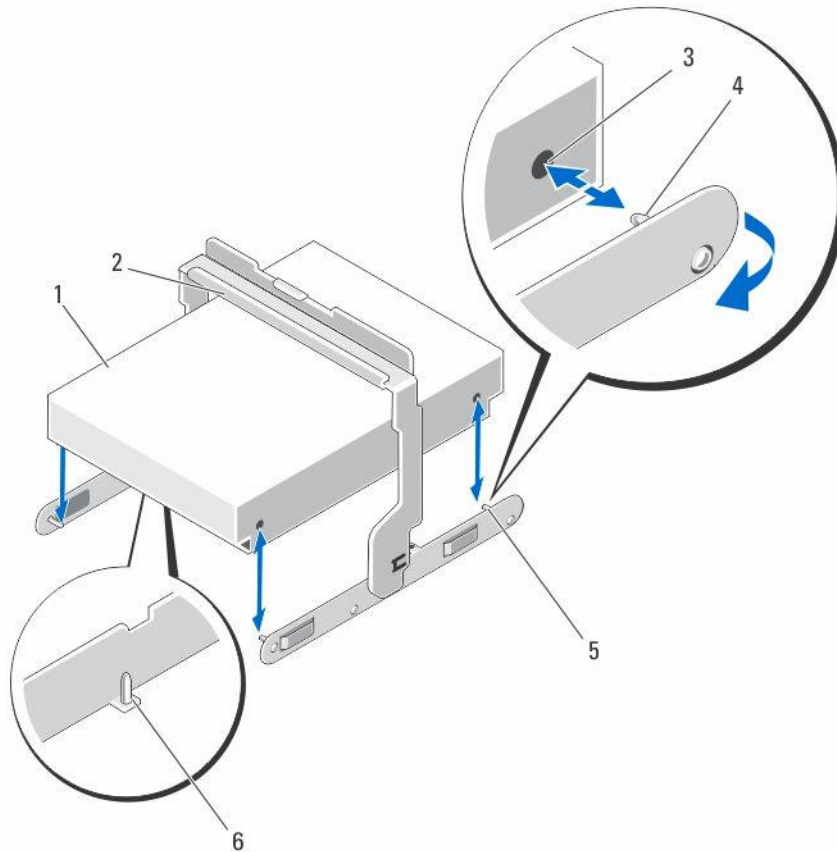

Figure 14. Removing and Installing the 3.5 Inch Physical Disk in a 3.5 Inch Physical-Disk Carrier

- | | | | |
|----|------------------------------------|----|--|
| 1. | 3.5 inch physical disk | 2. | release handle |
| 3. | slots on physical disk (4) | 4. | side guide pin (4) |
| 5. | carrier for 3.5 inch physical disk | 6. | bottom guide pins (2). Removed from newer carriers |

Installing A Physical Disk In A Physical-Disk Carrier

⚠ CAUTION: Many repairs may only be done by a certified service technician. You should only perform troubleshooting and simple repairs as authorized in your product documentation, or as directed by the online or telephone service and support team. Damage due to servicing that is not authorized by Dell is not covered by your warranty. Read and follow the safety instructions that came with the product.

1. Angle the physical disk into the physical-disk carrier.
2. Align the holes on one side (and if applicable, on the bottom) of the physical disk with the pins on the corresponding side of the physical-disk carrier.
3. Push out the edges on the other side of the physical-disk carrier, so that the holes on the other side of the physical disk align with the pins on the physical-disk carrier and snap the physical-disk carrier on to the physical disk.

Removing A Physical Disk From A Physical-Disk Drawer

△ CAUTION: Many repairs may only be done by a certified service technician. You should only perform troubleshooting and simple repairs as authorized in your product documentation, or as directed by the online or telephone service and support team. Damage due to servicing that is not authorized by Dell is not covered by your warranty. Read and follow the safety instructions that came with the product.

1. Remove the front bezel.
2. Identify the physical-disk drawer in which the faulty physical disk is installed.
3. Open the physical-disk drawer.
4. Identify and locate the faulty physical disk in the physical-disk drawer.
5. Press the release tab to disengage the physical-disk carrier handle.
6. Rotate the physical-disk carrier handle upward to disengage the physical disk from its connector.
7. Hold the physical-disk carrier handle and lift the physical disk away from the system.

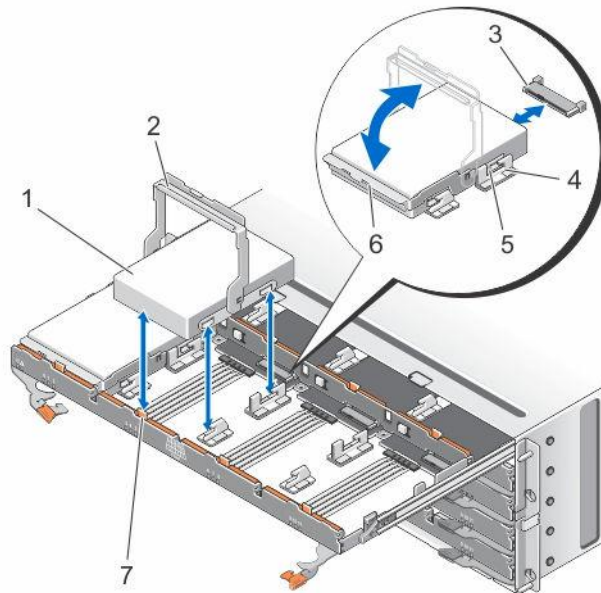

Figure 15. Removing and Installing the Physical Disk in the Physical-Disk Drawer

- | | |
|----------------------------|---------------------------------|
| 1. physical disk | 2. physical-disk carrier handle |
| 3. physical-disk connector | 4. notches (2) |
| 5. raised buttons (2) | 6. physical-disk carrier |
| 7. release tabs (12) | |

Installing A Physical Disk In A Physical-Disk Drawer

△ CAUTION: Many repairs may only be done by a certified service technician. You should only perform troubleshooting and simple repairs as authorized in your product documentation, or as directed by the online or telephone service and support team. Damage due to servicing that is not authorized by Dell is not covered by your warranty. Read and follow the safety instructions that came with the product.

1. Rotate the physical-disk carrier handle upward to the vertical position.
2. Align the two raised buttons with the notches on the physical-disk drawer, lower the physical disk into the slot in the physical-disk drawer.

✎ NOTE: Ensure that you install the physical disk from left to right and from front to back.

3. Rotate the handle downward until the physical disk is properly seated in the connector and the physical-disk carrier handle snaps into place.
4. Close the physical-disk drawer.
5. Install the front bezel.

SAS Chain Cables

There are two SAS cable chains on each side of the physical-disk drawer that connects the physical disks installed in the physical-disk drawer to the midplane.

- The connector on each SAS chain cable that connects to the physical-disk drawer is oriented horizontally.
- The connector on each SAS chain cable that connects to the midplane is oriented vertically.

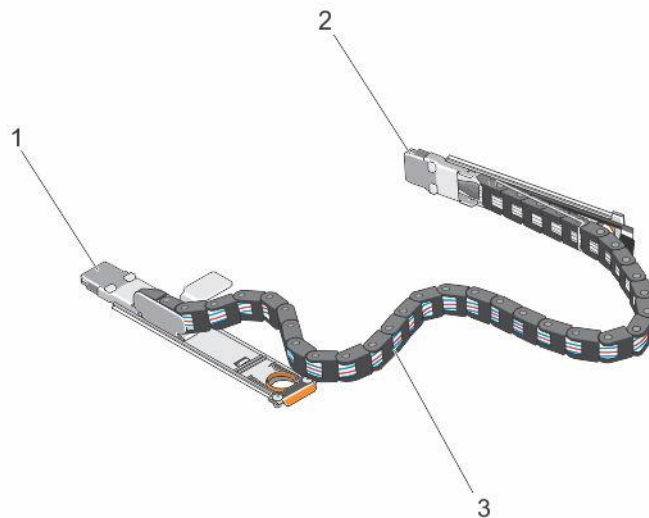

Figure 16. SAS Chain Cable Features

1. SAS cable connector on the physical-disk drawer (oriented horizontally)
2. SAS cable connector to the midplane (oriented vertically)
3. SAS chain cable (two per physical-disk drawer)

Removing The SAS Chain Cable(s)

△ CAUTION: Many repairs may only be done by a certified service technician. You should only perform troubleshooting and simple repairs as authorized in your product documentation, or as directed by the online or telephone service and support team. Damage due to servicing that is not authorized by Dell is not covered by your warranty. Read and follow the safety instructions that came with the product.

1. Remove the cooling fan module from one side on the back of the chassis.

△ CAUTION: If you are hot swapping the SAS cable chains, ensure that you complete the procedure on one side within ten minutes to avoid over heating of the storage enclosure.

△ CAUTION: Ensure that you are removing the SAS cable chain for the failed physical-disk drawer. Removing the SAS cable chain for the incorrect physical-disk drawer causes loss of data access and causes virtual disks to appear degraded in the MD Storage Manager.

2. Locate and identify the SAS chain cables for the failed physical-disk drawer.
3. To remove the chain cable mounting bracket from the midplane, insert your finger into the release tab (oriented vertically), and pull the mounting bracket completely out of the storage enclosure.
4. To remove the chain cable mounting bracket from the physical disk drawer, insert your finger into the release tab (oriented horizontally), and pull the mounting bracket completely out of the storage enclosure.
5. Install the cooling fan module.
6. Repeat the above mentioned steps for the SAS cable chain on the other side.

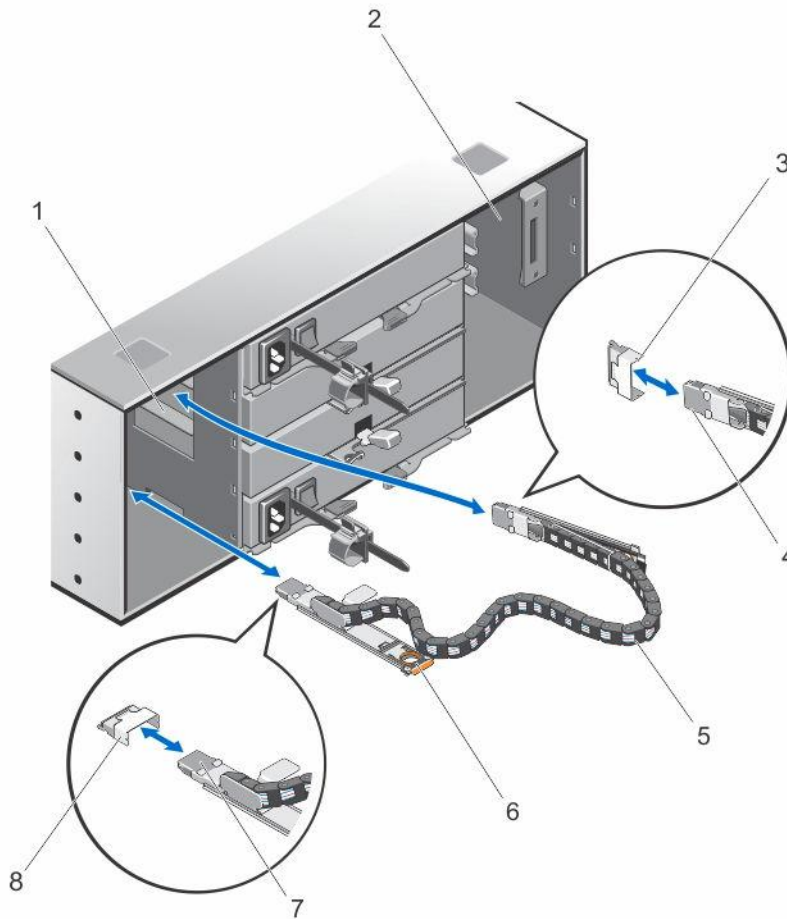

Figure 17. Removing and Installing the SAS Chain Cable(s)

- | | |
|--|--|
| 1. left cooling fan module bay | 2. right cooling fan module bay |
| 3. SAS cable connector on the midplane (two per physical disk drawer) | 4. SAS cable connector to the midplane (oriented vertically) |
| 5. SAS chain cable (two per physical disk drawer) | 6. release tab (oriented horizontally) |
| 7. SAS cable connector to the physical-disk drawer (oriented horizontally) | 8. SAS cable connector on the physical-disk drawer (oriented horizontally) |

Installing The SAS Chain Cable(s)

⚠ CAUTION: Many repairs may only be done by a certified service technician. You should only perform troubleshooting and simple repairs as authorized in your product documentation, or as directed by the online or telephone service and support team. Damage due to servicing that is not authorized by Dell is not covered by your warranty. Read and follow the safety instructions that came with the product.

1. Remove the cooling fan module from one side on the back of the chassis.

 **CAUTION: If you are hot swapping the SAS cable chains, ensure that you complete the procedure on one side within ten minutes to avoid over heating of the storage enclosure.**

2. Locate and identify the SAS chain cables for the new physical-disk drawer.
3. Connect the chain cable mounting bracket (oriented horizontally) to the physical-disk drawer.
4. Connect the chain cable mounting bracket (oriented vertically) to the midplane.
5. Install the cooling fan module.
6. Repeat the above mentioned steps for the SAS cable chain on the other side.

Enclosure Management Modules

Removing An Enclosure Management Module

 **CAUTION: Many repairs may only be done by a certified service technician. You should only perform troubleshooting and simple repairs as authorized in your product documentation, or as directed by the online or telephone service and support team. Damage due to servicing that is not authorized by Dell is not covered by your warranty. Read and follow the safety instructions that came with the product.**

 **CAUTION: To avoid damage to the sensitive EMI contacts on the module, do not stack the modules.**

1. Identify and locate the enclosure management module that you want to replace.
2. Disconnect the cables connected to the RAID controller module, enclosure management module, or server.
3. Push down on the release tab and pull the release lever away from the chassis.
4. Hold the release lever and pull the module away from the chassis.

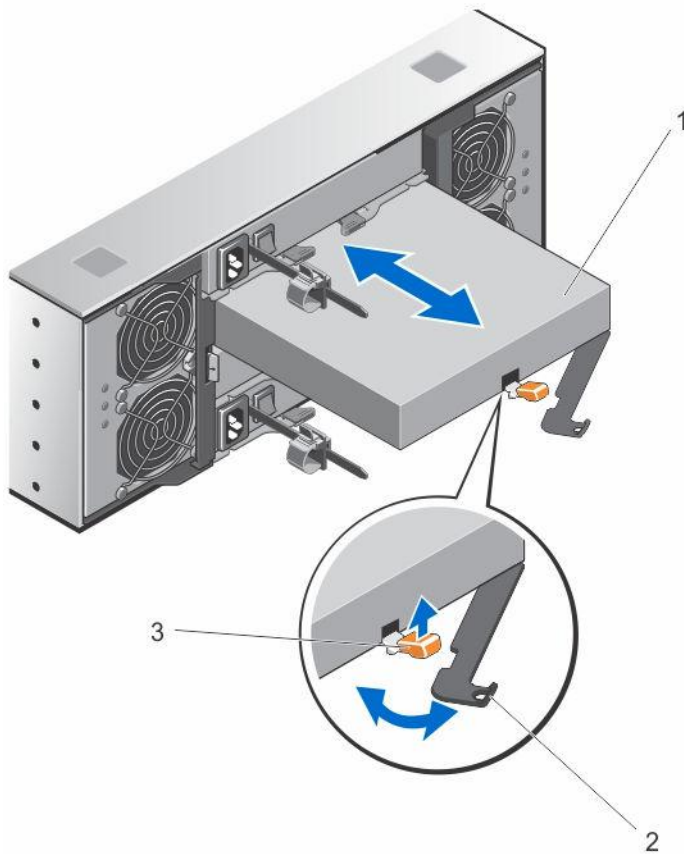

Figure 18. Removing and Installing an Enclosure Management Module

- | | |
|--------------------------------|------------------|
| 1. enclosure management module | 2. release lever |
| 3. release tab | |

Installing An Enclosure Management Module

⚠ CAUTION: Many repairs may only be done by a certified service technician. You should only perform troubleshooting and simple repairs as authorized in your product documentation, or as directed by the online or telephone service and support team. Damage due to servicing that is not authorized by Dell is not covered by your warranty. Read and follow the safety instructions that came with the product.

1. Insert the enclosure management module into the bay until it seats into place.
2. Push the release lever toward the chassis until it clicks into place.
3. Connect all the cables to the enclosure management module.

Power Supplies

Your system supports two hot-swappable 1755 W power supply modules.

When two identical power supplies are installed, the power supply configuration is redundant. In redundant mode, power is supplied to the system equally from both power supplies to maximize efficiency.

When one power supply module is removed or has failed, the power supply configuration is non-redundant. Power is supplied to the system only by a single power supply module.

 **CAUTION: Do not plug the enclosure into a standard power outlet. Your storage enclosure is shipped with two IEC C19 to C20 jumper cables. Connect the C19 plug to the enclosure's power supplies and the C20 plug to the power distribution unit (PDU) in the rack cabinet. For power redundancy, split the power connections from each enclosure into separate PDUs and connect the PDUs to external power receptacles on different circuits. The enclosure supports only 200 V to 240 V input sources.**

Removing A Power Supply Module

 **CAUTION: Many repairs may only be done by a certified service technician. You should only perform troubleshooting and simple repairs as authorized in your product documentation, or as directed by the online or telephone service and support team. Damage due to servicing that is not authorized by Dell is not covered by your warranty. Read and follow the safety instructions that came with the product.**

 **CAUTION: The system requires one power supply module for normal operation. Remove and replace only one power supply at a time in a system that is powered on.**

1. Identify and locate the faulty power supply module.

 **NOTE:** The **Service action required** indicator lights amber when there is a fault in the power supply module.

2. Disconnect the power cable from the power source and the power supply module you intend to remove and remove the cables from the cable securing strap.
3. Pull and rotate the two release levers away from the chassis until the power supply module is free from the slot.
4. Hold the power supply module and slide the power supply out of the chassis.

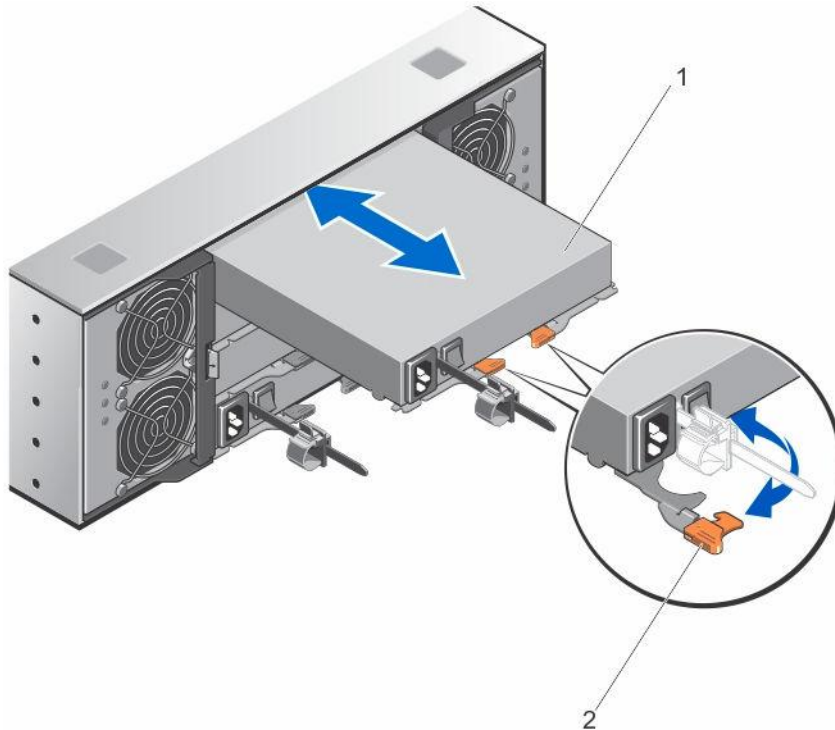

Figure 19. Removing and Installing the power supply module

- 1. power supply
- 2. release latch (2)

Installing A Power Supply Module

⚠ CAUTION: Many repairs may only be done by a certified service technician. You should only perform troubleshooting and simple repairs as authorized in your product documentation, or as directed by the online or telephone service and support team. Damage due to servicing that is not authorized by Dell is not covered by your warranty. Read and follow the safety instructions that came with the product.

Ensure that the power switch on the power supply module that you are installing, is in the **off** position.

1. Slide the new power supply module into the chassis until the power supply module is fully seated.
2. Rotate both the release lever toward the chassis until the power supply module locks into place.
3. Connect the power cable to the power supply module and plug the cable into a power outlet.

⚠ CAUTION: When connecting the power cable, secure the cable with the cable securing bracket.

📝 NOTE: When installing or hot-swapping a new power supply module, allow several seconds for the system to recognize the power supply module and determine its status. The power-supply status indicator turns green to signify that the power supply module is functioning properly.

Cooling Fan Modules

Your system supports two hot-swappable cooling fan modules.

Removing A Cooling Fan Module

 **CAUTION:** Many repairs may only be done by a certified service technician. You should only perform troubleshooting and simple repairs as authorized in your product documentation, or as directed by the online or telephone service and support team. Damage due to servicing that is not authorized by Dell is not covered by your warranty. Read and follow the safety instructions that came with the product.

 **CAUTION:** The cooling fans are hot-swappable. To maintain proper cooling while the system is on, replace only one fan at a time.

 **NOTE:** The procedure for removing each cooling fan module is identical.

Make sure that the **Service action allowed** indicator lights blue before you remove the cooling fan module. For more information, see [Cooling Fan Module LED Indicator Codes](#).

 **NOTE:** The Service action allowed indicator LED is not used in server attached configurations.

1. Identify and locate the failed cooling fan module.

 **CAUTION:** Remove the cooling fan module from the system only if the Service action allowed indicator lights blue. Removing the cooling fan module from the system when the Service action allowed indicator is off may damage the system.

 **NOTE:** The Service action allowed indicator LED is not used in server attached configurations.

2. Press the cooling fan module release latch to release the cooling fan module handle.
3. Rotate the cooling fan module handle away from the system, until the cooling fan module is released from the slot.
4. Holding the cooling fan module release handle, pull the cooling fan module away from the chassis.

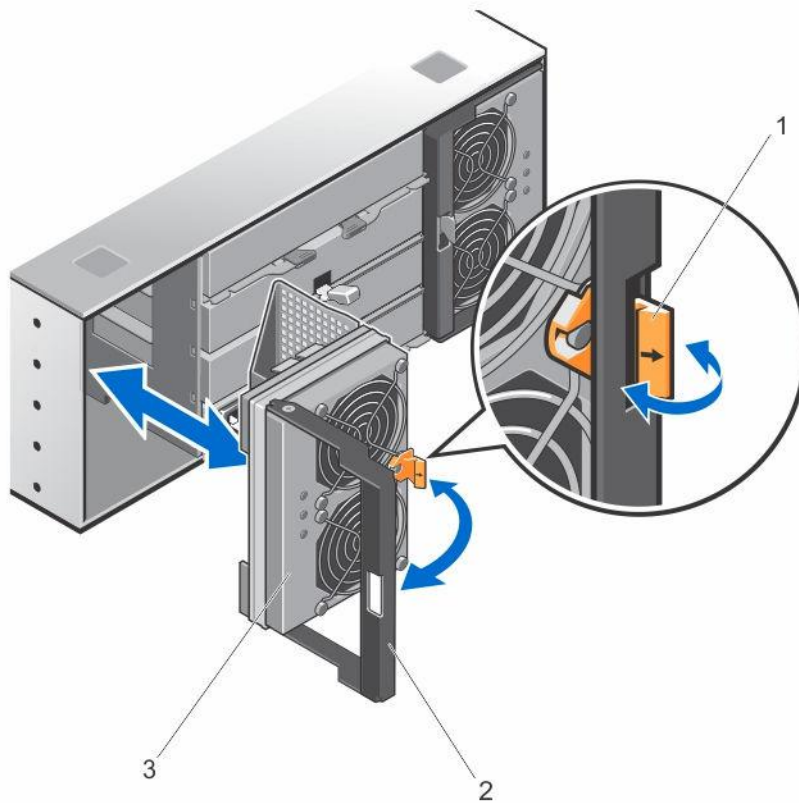

Figure 20. Removing and Installing the Cooling Fan Module

1. cooling fan module release latch
2. cooling fan module handle
3. cooling fan module

Installing A Cooling Fan Module

△ CAUTION: Many repairs may only be done by a certified service technician. You should only perform troubleshooting and simple repairs as authorized in your product documentation, or as directed by the online or telephone service and support team. Damage due to servicing that is not authorized by Dell is not covered by your warranty. Read and follow the safety instructions that came with the product.

1. Align the cooling fan module with the slot on the back of the chassis.
2. Slide the cooling fan module into the slot until it is properly seated.
3. Rotate the cooling fan module handle toward the chassis until the cooling fan module handle locks in place.

△ CAUTION: For proper cooling of the storage enclosure, ensure that all the cooling fans are operational at all times.

Troubleshooting your system

Safety first—for you and your system

-  **CAUTION:** Many repairs may only be done by a certified service technician. You should only perform troubleshooting and simple repairs as authorized in your product documentation, or as directed by the online or telephone service and support team. Damage due to servicing that is not authorized by Dell is not covered by your warranty. Read and follow the safety instructions that came with the product.

Troubleshooting External Connections

- Verify that the cables are connected to the correct ports before troubleshooting any external devices. For the location of the back-panel connectors on your storage enclosure, see [Back-Panel Features](#).
- Ensure that all the cables are securely attached to the external connectors on your enclosure.
- For information on cabling, see the Deployment Guide for your storage enclosure at dell.com/support/manuals.

Troubleshooting Power Supply Modules

-  **CAUTION:** Many repairs may only be done by a certified service technician. You should only perform troubleshooting and simple repairs as authorized in your product documentation, or as directed by the online or telephone service and support team. Damage due to servicing that is not authorized by Dell is not covered by your warranty. Read and follow the safety instructions that came with the product.

-  **CAUTION:** It is recommended that you turn off the host server before turning off the enclosure to prevent loss of data.

1. Locate the faulty power supply and determine the status of the LEDs.
 - If the AC power LED is not lit, check the power cord and power source into which the power supply module is plugged.
 - Connect another device to the power source to verify if it is working.
 - Connect the cable to a different power source.
 - Replace the power cable. If the problem is not resolved, see [Getting Help](#).
 - If the DC power LED is not lit, verify that the power switch is turned on. If the power switch is turned on, see step 2.
 - If the power supply module's fault indicator is lit, see [Getting Help](#).

 **CAUTION:** Power supply modules are hot-swappable. The enclosure can operate on a single power supply module; however both modules must be installed to ensure proper cooling. A single power supply module can be removed from a powered-on enclosure for a maximum period of five minutes. Beyond that time, the enclosure may automatically shut down to prevent damage.

2. Reseat the power supply module by removing and reinstalling it.

 **NOTE:** After installing a power supply module, allow several seconds for the enclosure to recognize the power supply module and to determine if it is working properly.

If the problem is not resolved, see [Getting Help](#).

Troubleshooting Enclosure Cooling Problems

 **CAUTION:** Many repairs may only be done by a certified service technician. You should only perform troubleshooting and simple repairs as authorized in your product documentation, or as directed by the online or telephone service and support team. Damage due to servicing that is not authorized by Dell is not covered by your warranty. Read and follow the safety instructions that came with the product.

Ensure that none of the following conditions exist:

- Ambient temperature is too high, as a physical-disk drawer is left open for an extended period.
- External airflow is obstructed.
- The cooling fan module is removed or has failed.

If the problem is not resolved, see [Getting Help](#).

Troubleshooting Physical Disks

 **CAUTION:** Many repairs may only be done by a certified service technician. You should only perform troubleshooting and simple repairs as authorized in your product documentation, or as directed by the online or telephone service and support team. Damage due to servicing that is not authorized by Dell is not covered by your warranty. Read and follow the safety instructions that came with the product.

1. Check the physical disk to ensure that the most current version of the firmware is installed, if possible. For more information, see the *Dell Storage PowerTools Server Hardware Manager Administrator's Guide* at Dell.com/dsmsmanuals.

2. Remove the physical disk from the system.

 **NOTE:** You must ensure that you check the physical disk indicators before removing the faulty physical disk from the system.

3. Check the physical disks and the midplane to ensure that the connectors are not damaged.
4. Reinstall the physical disk.
5. If the problem is not resolved, replace the failed physical disk.

If the problem persists, see [Getting Help](#).

Troubleshooting A Wet Storage Enclosure

 **CAUTION:** Many repairs may only be done by a certified service technician. You should only perform troubleshooting and simple repairs as authorized in your product documentation, or as directed by the online or telephone service and support team. Damage due to servicing that is not authorized by Dell is not covered by your warranty. Read and follow the safety instructions that came with the product.

1. Turn off the enclosure and disconnect all the cables.
2. Remove the following components from the enclosure:
 - Physical disks
 - Power supply modules
 - Cooling fan modules
3. Let the system dry thoroughly for at least 24 hours.
4. Reinstall the components you removed in step 2.
5. Connect all the cables and turn on the enclosure.

Technical Specifications

Physical Disks

Physical disks

Up to sixty 3.5 inch or 2.5 inch SAS or nearline SAS physical disks or 2.5 inch SAS SSDs

 **NOTE:** For more details on the latest supported physical disks, physical disk types, and supported quantities, see the *Dell Storage Enclosure Support Matrix*.

Enclosure Management Modules

Dell PowerVault MD3060e storage enclosures

Supports 60 physical disks

Redundant path connectivity provides redundant data paths to each hard drive

SAS connectors

Two SAS ports (marked IN) to connect to host server(s) or to expand the MD series storage dense enclosure

Third SAS port labelled OUT. Port can be used for further storage enclosure expansion or storage enclosure fault tolerance.

 **NOTE:** SAS connectors are SFF-80644 compliant.

Serial connector (debug port)

Six pin port

 **NOTE:** For technical support use only.

Power

AC power supply (per power supply)

Wattage

1755 W

Heat dissipation (maximum)

5988 BTU/hr

 **NOTE:** Heat dissipation is calculated using the power supply wattage rating. The heat dissipation values are for the entire system which includes chassis and two EMMs.

Voltage

220 V AC, autoranging, 50 Hz/60 Hz

Power

-  **NOTE:** This system is also designed to be connected to IT power systems with a phase to phase voltage not exceeding 230 V.

Environmental

-  **NOTE:** For additional information about environmental measurements for specific system configurations, see [dell.com/environmental_datasheets](https://www.dell.com/environmental_datasheets).

Temperature

- Operating
Continuous operation: 10 °C to 35 °C (50 °F to 95 °F) at 20% to 80% relative humidity (RH), with 26 °C maximum dew point. De-rate maximum allowable dry bulb temperature at 1 °C/300 m (1 °F per 550 ft) above 900 m (2952.75 ft).

-  **NOTE:** For information on supported expanded operating temperature range and configurations, see the Owner's Manual at [Dell.com/support/manuals](https://www.Dell.com/support/manuals).

- Storage
–40 °C to 65 °C (–40 °F to 149 °F) with a maximum temperature gradation of 20 °C per hour

Relative humidity

- Operating
20% to 80% (noncondensing) with maximum humidity gradation of 10% per hour
- Storage
5% to 95% at a maximum wet bulb temperature of 38 °C (100.4 °F)

Maximum vibration

- Operating
0.26 G_{rms} at 5 Hz to 350 Hz in operational orientation
- Storage
1.88 G_{rms} at 10 Hz to 500 Hz for 15 minutes (all six sides tested)

Maximum shock

- Operating
One shock pulse in the positive z axis of the system at 31 G for 2.6 ms in the operational orientation
- Storage
Six consecutively executed shock pulses in the positive and negative x, y, and z axes (one pulse on each side of the system) at 71 G for up to 2 ms
Six consecutively executed shock pulses in the positive and negative x, y, and z axes (one pulse on each side of the system) of 22 G faired square wave pulse with velocity change at 200 inches/second (508 centimeters/second)

Environmental

Altitude

Operating

Maximum 3000 m (9,842 ft)

Storage

Maximum 12192 m (40,000 ft)

Airborne contaminant level

Class

G1 as defined by ISA-S71.04-1985

Getting help

Locating your system service tag

Your system is identified by a unique Express Service Code and Service Tag number. The Express Service Code and Service Tag are found on the front of a physical DR Series system by pulling out the information tag. This can also be found on the support tab in the GUI. This information is used by Dell to route support calls to the appropriate personnel.

Contacting Dell

Dell provides several online and telephone-based support and service options. If you do not have an active Internet connection, you can find contact information on your purchase invoice, packing slip, bill, or Dell product catalog. Availability varies by country and product, and some services may not be available in your area. To contact Dell for sales, technical support, or customer-service issues:

1. Go to **dell.com/support**.
2. Select your country from the drop-down menu on the bottom right corner of the page.
3. For customized support:
 - a. Enter your system Service Tag in the **Enter your Service Tag** field.
 - b. Click **Submit**.
The support page that lists the various support categories is displayed.
4. For general support:
 - a. Select your product category.
 - b. Select your product segment.
 - c. Select your product.
The support page that lists the various support categories is displayed.

Documentation feedback

If you have feedback for this document, write to **documentation_feedback@dell.com**. Alternatively, you can click on the **Feedback** link in any of the Dell documentation pages, fill out the form, and click **Submit** to send your feedback.